

 cybex
PLATINUM

COYA





EN WARNING
DE WARNUNG
ES ADVERTENCIA
FR AVERTISSEMENT
PT AVISOS
IT ATTENZIONE
NL WAARSCHUWING
PL OSTRZEŻENIE
CS UPOZORNĚNÍ
SK UPOZORNENIE
SL OPOZORILO
HR UPOZORENJE
HU FIGYELMEZTETÉS
SE VARNING
NO ADVARSEL
FI VAROITUS
DA ADVARSEL
ET HOIATUS
LV BRĪDINĀJUMS
LT PERSPĖJIMAS
RU ВНИМАНИЕ
UK УВАГА
TR UYARI
EL ΠΡΟΕΙΔΟΠΟΙΗΣΗ
RO AVERTISMENTE
IS VIÐVÖRUN
MT TWISSJA

AR
FA
YUE 警告
CMN 警告
JA 警告
KO 경고
BG ПРЕДУПРЕЖДЕНИЕ
SR UPOZORENJE
MS AMARAN
HI चेतावनी
TH คำเตือน
SQ PARALAJMËRIM
BS UPOZORENJE
ME UPOZORENJE
MK ПРЕДУПРЕДУВАЊЕ
HY զգուշացում
VI CẢNH BÁO

تحذير
اخطار



EN Tutorial video
DE Videoanleitung
ES Tutorial en video
FR Vidéo de démonstration
PT Video tutorial
IT Video tutorial
NL Instructievideo
PL Film instruktażowy
CS Vyučové video
SK Vyučové video
SL Video z navodili
HR Video s uputama
HU Bemutatóvideo
SE Videosjällstudiekurs
NO Oppføringsvideo
FI Opetusvideo
DA Vejledende video
ET Õppevideo
LV Ar mācību video
LT Mokomasis vaizdo įrašas
RU Обучающее видео
UK Навчальне відео
TR Öğretici video
EL Εκπαιδευτικό βίντεο
RO Video tutorial
IS Kennslumyndband
MT Tutorial fuq vidjow

AR
FA
YUE 教程視頻
CMN 教程視頻
JA チュートリアルビデオ
KO 튜토리얼 동영상
BG Учебно видео
SR Video sa uputstvima
MS Video tutorial
HI ऑटोरियल वीडियो
TH ideo tutorial
SQ Video udhëzuese
BS Video sa uputstvima
ME Video sa uputstvima
MK Видеоупатство
HY Παιδαγωγική ταινία
VI Video hướng dẫn

ویدیو تدریسی
ویندوزی آموزشی



= 10

EN Maximum weights	TR Maksimum ağırlıklar
DE Maximalgewichte	EL Μέγιστο βάρος
ES Pesos máximos	RO Greutăți maxime
FR Poids maximum	IS Hámarksþyngd
PT Pesos máximos	MT Pizżijiet massimi
IT Peso massimo	AR الأوزان القصوى
NL Maximengewicht	FA حداکثر وزن
PL Dopuszczalna waga	YUE 最大重量
CS Maximální hmotnosti	CMN 最大重量
SK Maximálne hmotnosti	JA 最大重量
SL Največje teže	KO 최대 하중
HR Maksimalne težine	BG Максимални тежла
HU Maximális súlyok	SR Maksimalne težine
SE Max.vikter	MS Berat maksimum
NO Maksimumsvækt	HI अधिकतम वजन
FI Enimmäispainot	TH น้ำหนักสูงสุด
DA Maksimumvægt	SQ Peshat maksimale
ET Maksimaalne kaal	BS Maksimalne težine
LV Maksimālais svars	ME Maksimalne težine
LT Didžiausi svoriai	MK Максимални тежини
RU Максимальная масса	HY Առավելագույն քաշեր
UK Максимальна вага	VI Cước mức sản nặng tối đa

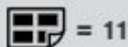

= 11

EN Product registration	TR Ürün kaydı
DE Produktregistrierung	EL Καταχώριση προϊόντος
ES Registro del producto	RO Înregistrarea produsului
FR Enregistrement du produit	IS Skráning tækis
PT Registo do produto	MT Registrazzjoni tal-prodott
IT Registrazione del prodotto	AR تسجيل المنتج
NL Productregistratie	FA ثبت محصول
PL Rejestracja produktu	YUE 產品註冊
CS Registrace výrobku	CMN 产品注册
SK Registrácia výrobku	JA 製品の登録
SL Registracija izdelka	KO 제품 등록
HR Registracija proizvoda	BG Регистрация на продукта
HU Termékregisztráció	SR Registracija proizvoda
SE Produktregistrering	MS Pendaftaran produk
NO Produktregistrering	HI उत्पाद पंजीकरण
FI Tuotteen rekisteröinti	TH การลงทะเบียนผลิตภัณฑ์
DA Produktregistrering	SQ Regjistrimi i produktit
ET Toote registreerimine	BS Registracija proizvoda
LV Produkta registrācija	ME Registracija proizvoda
LT Gaminio registracija	MK Регистрација на производ
RU Регистрация продукта	HY Արարվող արտադրվ
UK Реєстрація продукту	VI Đăng ký sản phẩm



 = 12

EN	Set up	TR	Kurulum
DE	Aufbau	EL	Στήσιμο
ES	Instalación	RO	Setare
FR	Montage	IS	Uppsetning
PT	Preparação	MT	Konfigurazzjoni
IT	Configurazione	AR	
NL	Opbouw	FA	تنصوب سره کردن
PL	Montaż	YUE	設置
CS	Nastavení	CMN	设置
SK	Nastavenie	JA	セットアップ
SL	Nastavitev	KO	설정
HR	Postavljanje	BG	Настройка
HU	Felszerelés	SR	Postavljanje
SE	Inställning	MS	Persediaan
NO	Oppsett	HI	सेट अप
FI	Asennus	TH	การติดตั้ง
DA	Opsætning	SQ	Konfigurimi
ET	Seadistamine	BS	Postavljanje
LV	Uzstādīšana	ME	Postavljanje
LT	Nuostatos	MK	Поставување
RU	Установка	HY	Վարձաւորում
UK	Встановлення	VI	Cài đặt



 = 14

EN	Brake	TR	Fren
DE	Bremse	EL	Φρένο
ES	Freno	RO	Frână
FR	Frein	IS	Bromsa
PT	Bloqueio	MT	Brojok
IT	Freno	AR	
NL	Rem	FA	المكابح ترمز
PL	Hamulec	YUE	剎車
CS	Brzda	CMN	剎車
SK	Brzda	JA	ブレーキ
SL	Zavora	KO	브레이크
HR	Kočnica	BG	Спирачка
HU	Fék	SR	Kočnica
SE	Broms	MS	Brak
NO	Broms	HI	ब्रेक
FI	Jarru	TH	เบรก
DA	Bremse	SQ	Frenat
ET	Pidur	BS	Kočnica
LV	Bremze	ME	Kočnica
LT	Stabdys	MK	Сопирачка
RU	Тормоза	HY	Արգելակ
UK	Гальма	VI	Phanh thắng

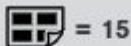

= 15

EN	Folding	TR	Katlama
DE	Faltung	EL	Ανοδμίωση
ES	Plegado	RO	Pliere
FR	Pliant	IS	Brjota saman
PT	Fecho	MT	Tiwi
IT	Ripiegamento	AR	
NL	Vouwen	FA	
PL	Składanie	YUE	折疊
CS	Skládání	CMN	折疊
SK	Zloženie	JA	折りたたみ
SL	Zlaganje	KO	접기
HR	Preklapanje	BG	Сгъване
HU	Összeeszkálás	SR	Preklapanje
SE	Ihopfallning	MS	Lipat
NO	Sammonlogging	HI	ढोँफिटल
FI	Kokoon taittaminen	TH	พับกระดาษ
DA	Sammenklapning	SQ	Palosja
ET	Kokkuvoltimine	BS	Preklapanje
LV	Salocīšana	ME	Preklapanje
LT	Lankstymas	MK	Склопување
RU	Складывание	HY	ծախելը
UK	Складання	VI	Gấp lại

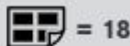
قابلية للطي
تاكرون

= 18

EN	Harness	TR	Emniyet kemeri
DE	Gurtsystem	EL	Συγκράτηση
ES	Arnés	RO	Centură
FR	Harnais	IS	Beisli
PT	Arnês	MT	Cinga tas-sigurtà
IT	Imbracatura	AR	
NL	Harnas	FA	
PL	Szelki	YUE	安全带
CS	Popruh	CMN	安全带
SK	Popruh	JA	安全ベルト
SL	Varnostni pas	KO	안전띠
HR	Sustav vezivanja	BG	Сбруя
HU	Biztonsági öv	SR	Sistem vezivanja
SE	Sele	MS	Abah-abah
NO	Boltesystem	HI	बन्धक
FI	Vyöjärjestelmä	TH	เชือกนิรภัย
DA	Selesystem	SQ	Pajimet
ET	Turvanihmad	BS	Sistem vezivanja
LV	Drošības josta	ME	Sistem vezivanja
LT	Diržai	MK	Сигурносен каиш
RU	Ремни безопасности	HY	Անվտանգող
UK	Ремінь	VI	Dây an toàn

طاقم الشد
سوستم مهار

 = 22

EN	Backrest	EL	Πλάτη
DE	Rückenlehne	RO	Spătar
ES	Respaldo	IS	Bak
FR	Dossier	MT	Serh id-dahar
PT	Encosto de costas	AR	مسند الظهر
IT	Schienale	FA	پشتی
NL	Rugleuning	YUE	靠背
PL	Oparcie	CMN	靠背
CS	Opěradlo	JA	背もたれ
SK	Operadlo	KO	등받이
SL	Naslonjalo	BG	Облегалка
HR	Naslon	SR	Naslon
HU	Hattámia	MS	Penyandar belakang
SE	Ryggstöd	HI	किन्नेट्ट
NO	Ryggstøle	TH	พนักพิง
FI	Selkänöja	SQ	Mbështetësja e shpinës
DA	Rygstøen	BS	Naslon
ET	Seljatugi	ME	Naslon
LV	Atzvoltnē	MK	Наслон за грб
LT	Nugaros atlošas	HY	Թիկնակ
RU	Спинка	VI	Phấn tựa lưng
UK	Спинка		
TR	Arkalık		

 = 24

EN	Legrest	EL	Στήριγμα ποδιών
DE	Beinstütze	RO	Support picior
ES	Reposapiés	IS	Fotahvíla
FR	Repose-pieds	MT	Serh is-saqajn
PT	Apoio de pernas	AR	مسند الساق
IT	Poggiagambe	FA	پاهایی
NL	Beensteun	YUE	腿托
PL	Podnóżek	CMN	腿托
CS	Opěrka nohou	JA	足のせ
SK	Opierka nôh	KO	다리받이
SL	Naslon za noge	BG	Подложка за крака
HR	Naslon za noge	SR	Naslon za noge
HU	Lábtartó	MS	Tempat letak kaki
SE	Benstöd	HI	नेरनेट्ट
NO	Benstøtte	TH	ที่วางเท้า
FI	Jalkatuki	SQ	Mbështetësja e këmbëve
DA	Benstøtte	BS	Naslon za noge
ET	Jalatugi	ME	Naslon za noge
LV	Kāju balsts	MK	Наслон за ноге
LT	Kojų atrama	HY	Ուղեղի ռեւմակս կտր
RU	Подставка для ног	VI	Phấn tựa chân
UK	Опора для ніг		
TR	Bacak desteği		



EN	Sun canopy	EL	Κουκούλα για τον ήλιο
DE	Sonnenwerdeck	RO	Copertină
ES	Capota para el sol	IS	Solartjald
FR	Pare-soleil	MT	Kopertura mix-komx
PT	Capota solar	AR	مظلة الشمس
IT	Parasole	FA	سولبان
NL	Zonnepak	YUE	遮阳篷
PL	Oslona przeciwsłoneczna	CMN	遮阳篷
CS	Stříška proti slunci	JA	日よけカ/一
SK	Strieška proti slnku	KO	선채노피
SL	Senčnik za zaščito pred soncem	BG	Тента
HR	Tenda za sunce	SR	Tenda za sunce
HU	Kupola	MS	Kanopi matahari
SE	Solsufflett	HI	छाया छतरी
NO	Solskjerm	TH	ม้านั่งร่มเงา
FI	Aurinkokatos	SQ	Strea për diellin
DA	Solkaleche	BS	Tenda za sunce
ET	Päikesevari	ME	Tenda za sunce
LV	Saulēs aizsargs	MK	Стреа за сонце
LT	Stogelis nuo saulės	HY	Արևապաշտպան օտնիկ
RU	Солнцезащитный козырек	VI	Mái che nắng
UK	Тент від сонця		
TR	Güneş barlığı		

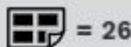

EN	Removing the wheels	EL	Αφαίρεση των τροχών
DE	Entfernen der Räder	RO	Îndepărtarea roților
ES	Quitar las ruedas	IS	Fjarlægja hjól
FR	Retrait des roues	MT	Tnehhija tar-roti
PT	Remover as rodas	AR	فك العجلات
IT	Rimozione delle ruote	FA	باز کردن چرخ ها
NL	De wielen verwijderen	YUE	拆卸車輪
PL	Zdejmowanie kolek	CMN	拆卸車輪
CS	Odstranění koloček	JA	車輪の取り外し
SK	Odstránenie koliesok	KO	휠 제거
SL	Odstranjevanje koles	BG	Демонтиране на колелата
HR	Uklanjanje kotača	SR	Uklanjanje točkova
HU	Kerekék eltávolítása	MS	Menanggalkan roda
SE	Ta bort hjulen	HI	पहियों को हटाना
NO	Fjerne hjulene	TH	นำล้อออก
FI	Pyörien poisto	SQ	Heqja e rrotave
DA	Fjernelse af hjulene	BS	Uklanjanje točkova
ET	Rataste eemaldamine	ME	Uklanjanje točkova
LV	Riteņu atvienošana	MK	Отстранување на тркалата
LT	Ratų nuėmimas	HY	Արմխլետրը հանելը
RU	Снятие колес	VI	Tháo bánh xe
UK	Зняття коліс		
TR	Tekerlekleri çıkarma		



= 27

EN Removing the fabric	EL Αφαίρεση του υφάσματος
DE Entfernen des Bezuges	RO Îndepărtarea țesăturii
ES Quitar la tela	IS Fjarlægja efni
FR Retrait du tissu	MT Tnehhija tad-drapp
PT Remover o tecido	AR قلع القماش
IT Rimozione del tessuto	FA برداشتن پارچه
NL De stof verwijderen	YUE 拆除罩布
PL Zdejmowanie pokrycia	CMN 拆除罩布
CS Odstranění látky	JA カ/カバーの取り外し
SK Odstránenie látky	KO 패브릭 제거
SL Odstranjevanje blaga	BG Демонтирано на плато
HR Uklanjanje tkanine	SR Uklanjanje tkanine
HU Huzat eltávolítása	MS Menanggalkan fabrik
SE Ta bort tyget	HI ऊपडा हटाना
NO Fjerne stoffet	TH ๓๓๓๓๓๓
FI Kankaan poisto	SQ Heqja e copës
DA Fjernelse af stoffet	BS Uklanjanje tkanine
ET Kanga eemaldamine	ME Uklanjanje tkanine
LV Pārklājuma atvienošana	MK Отстранување на навлуката
LT Audinio nuėmimas	HY Գործվածքը հանելը
RU Снятие ткани	VI Tháo phần vải bọc
UK Зняття матерія	
TR Kılıf çıkarma	



= 44

EN Rain cover	EL Καλύπτρα βροχής
DE Regenwerdeck	RO Prelată de ploaie
ES Funda para la lluvia	IS Regn yfirbroiðisla
FR Housse de pluie	MT Ghata mix-xita
PT Capa de chuva	AR غطاء المطر
IT Parapioggia	FA روکش باران
NL Regenhoes	YUE 防雨罩
PL Osłona od deszczu	CMN 防雨罩
CS Plaštěnka	JA 雨ふし
SK Kryt proti dažďu	KO 레인커버
SL Dožna prevleka	BG Дъждобран
HR Pokrivač za kišu	SR Pokrivač za kišu
HU Esővédő	MS Pelindung hujan
SE Regnskydd	HI रैन कवर
NO Kallesje	TH ๓๓๓๓๓๓
FI Sadesuoja	SQ Mbulesë për shiun
DA Regnslag	BS Pokrivač za kišu
ET Vihmakate	ME Pokrivač za kišu
LV Pretlietus pārvalks	MK Прокривна за дожд
LT Uždangalas nuo lietaus	HY Անձրև ապացտպակ
RU Дождевик	VI Tấm che mưa
UK Дощовик	
TR Yağmurluk	



max. 0,5 kg

max. 22 kg

max. 5 kg

a



1



b

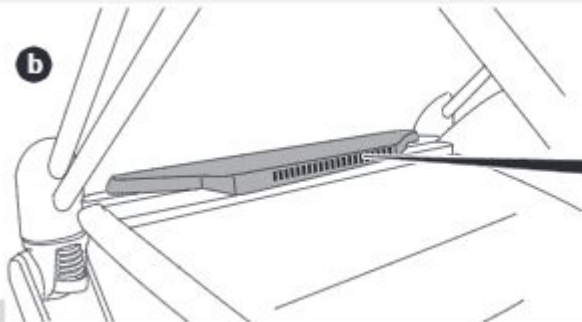

2

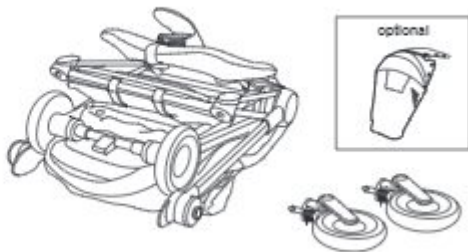

1

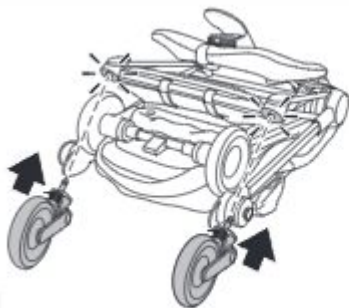

2

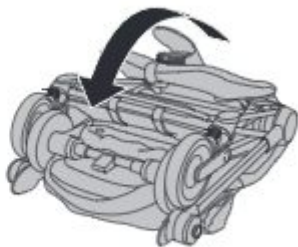

3

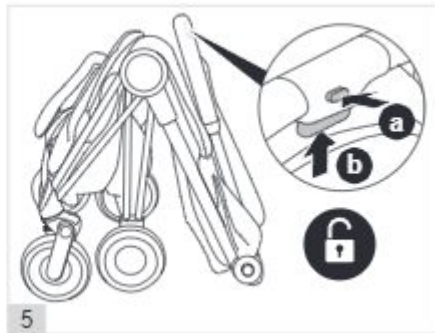
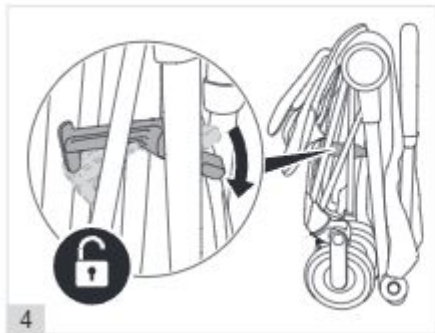

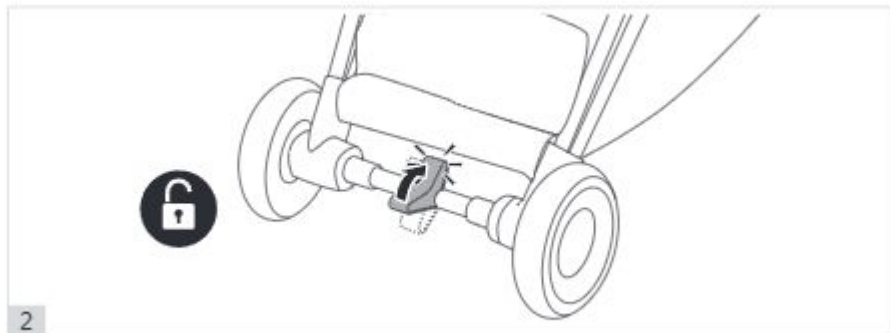
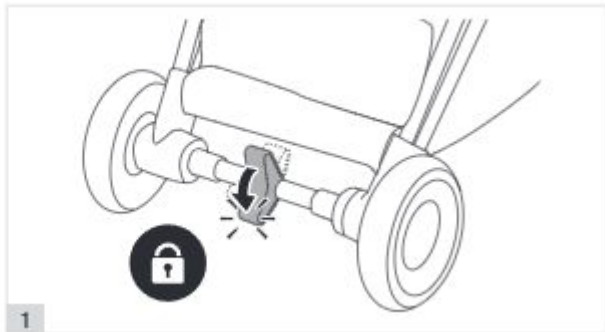

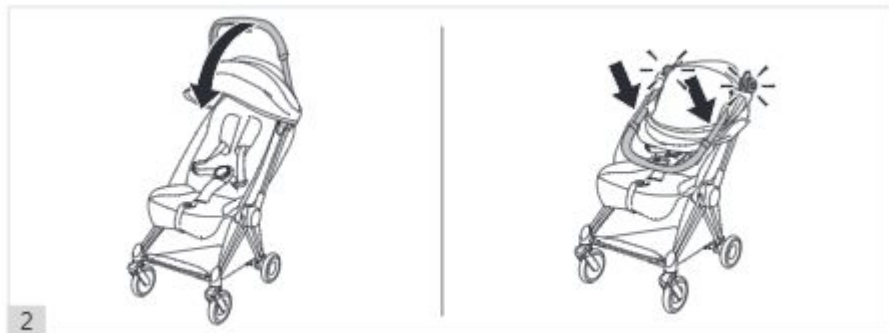
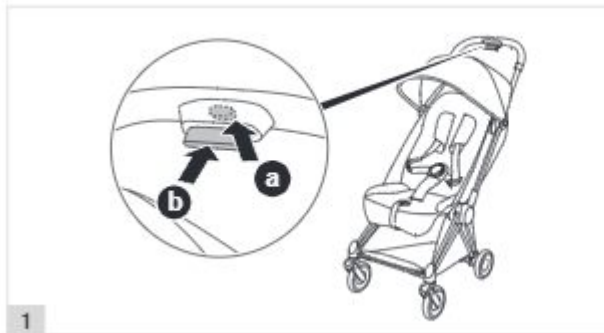



3



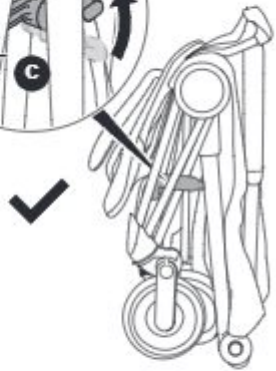
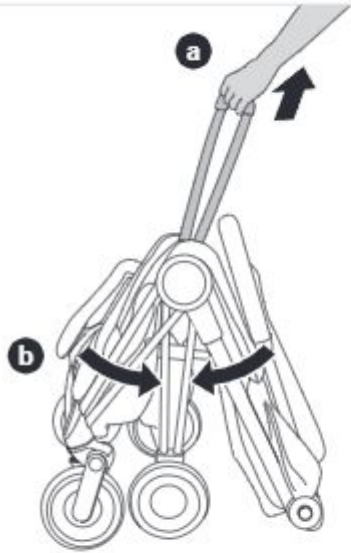

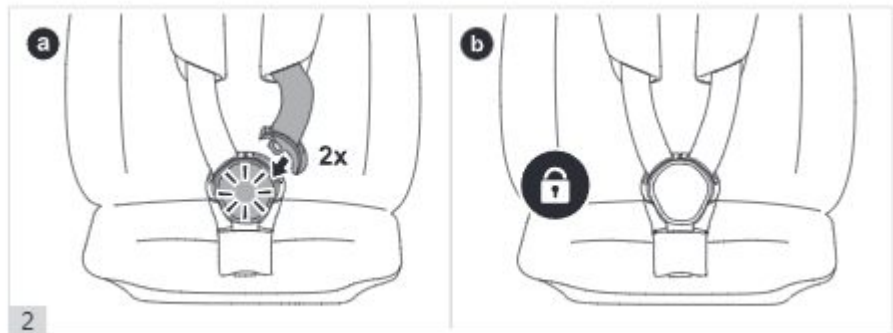
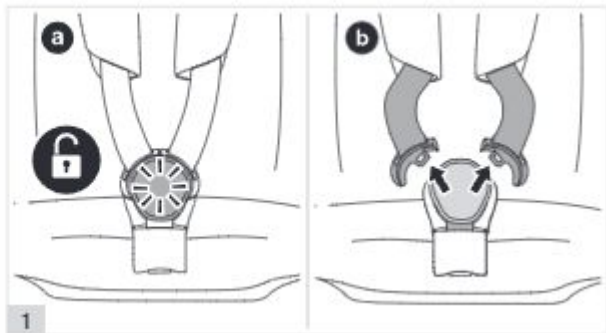

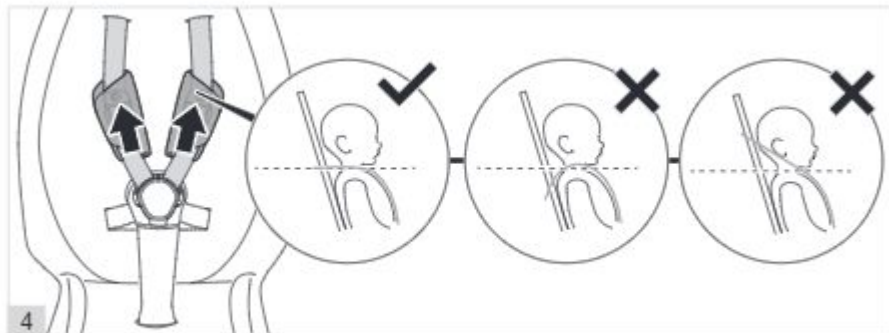
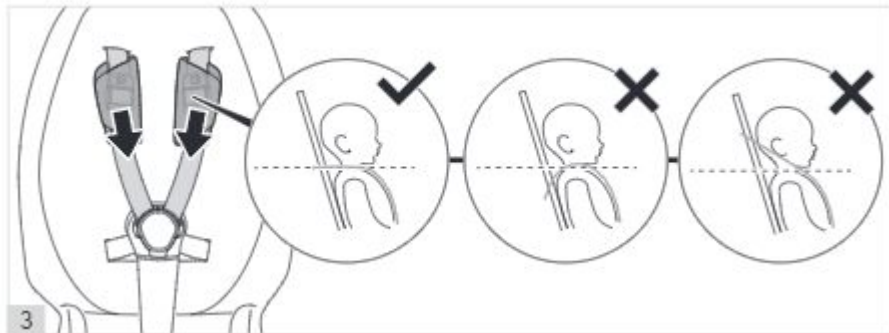

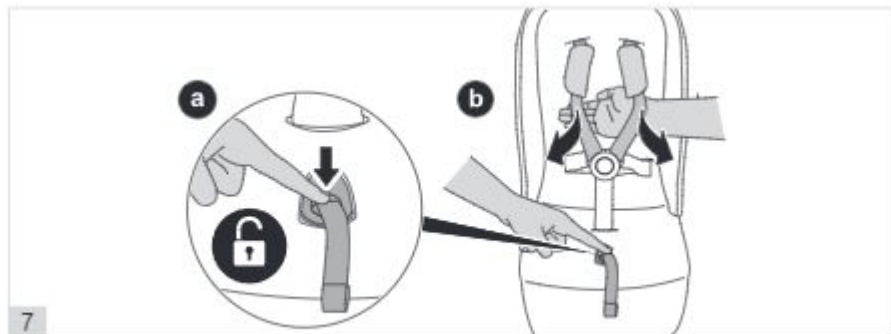

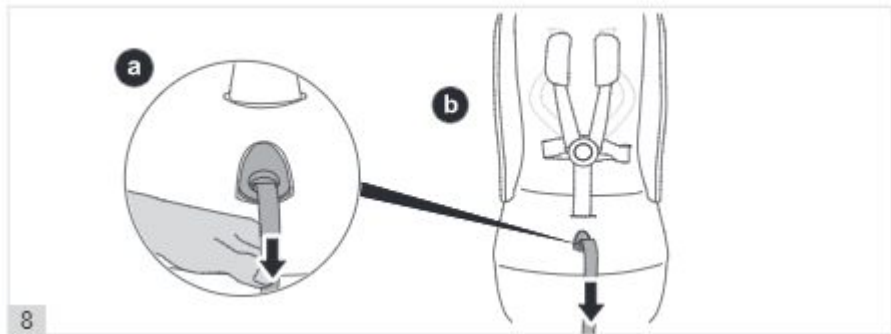



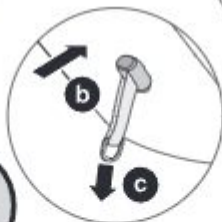





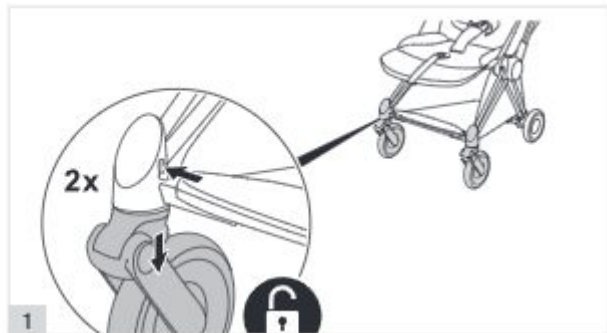

1

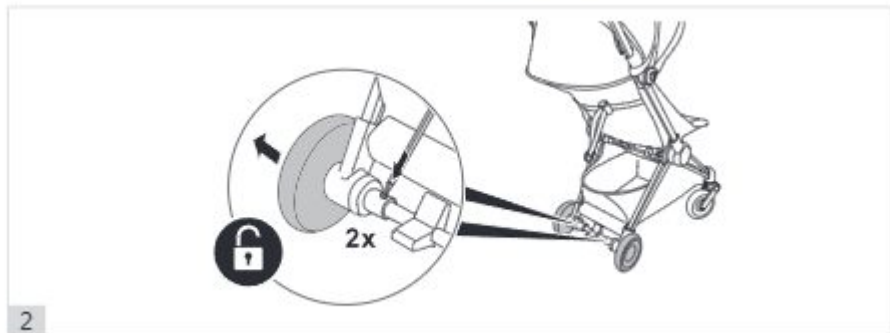

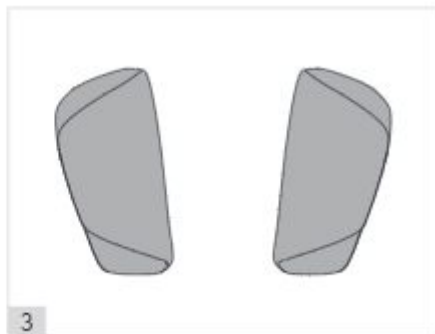
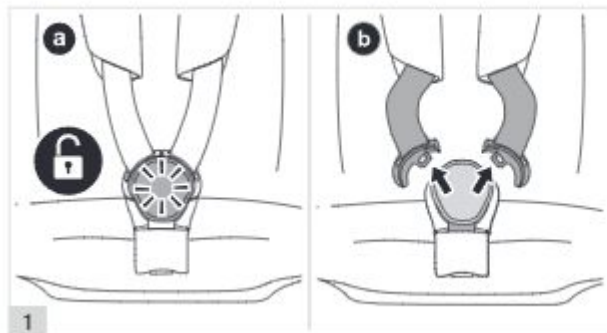

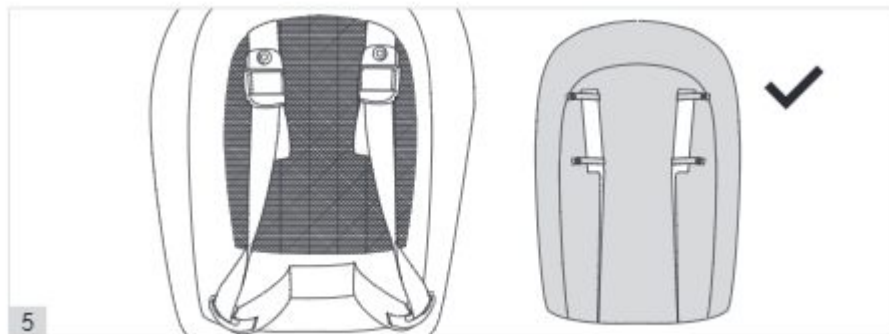
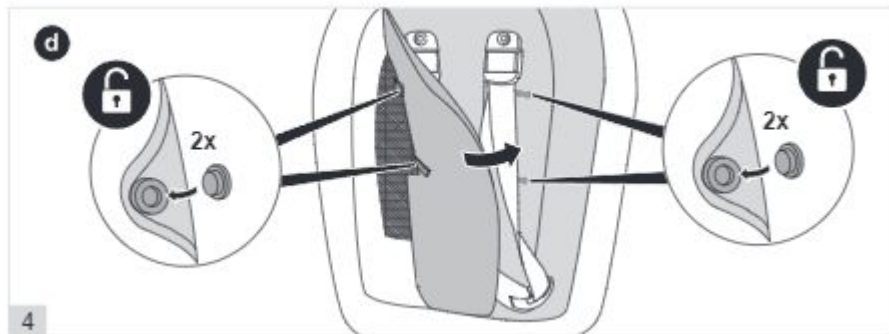

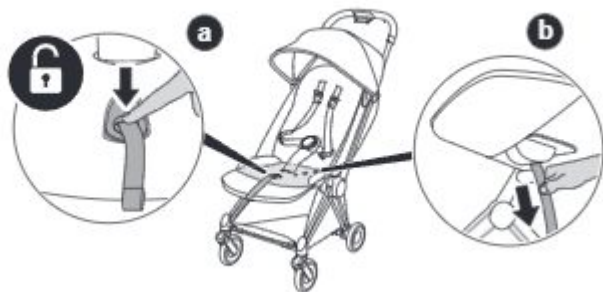

6



7

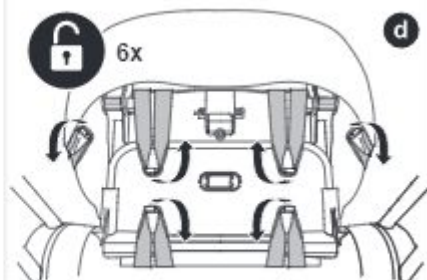

8



e

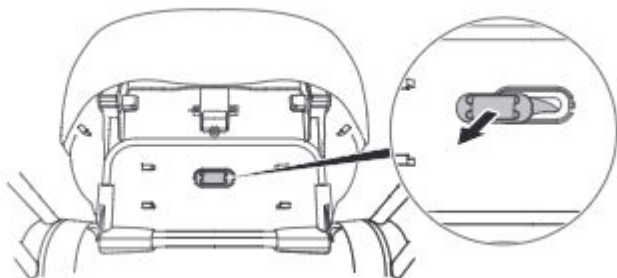

9

f

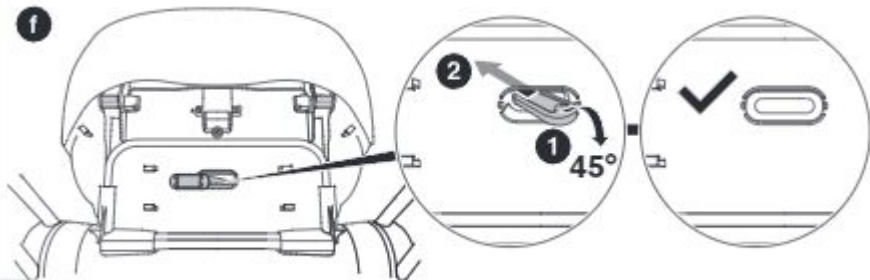

10



11

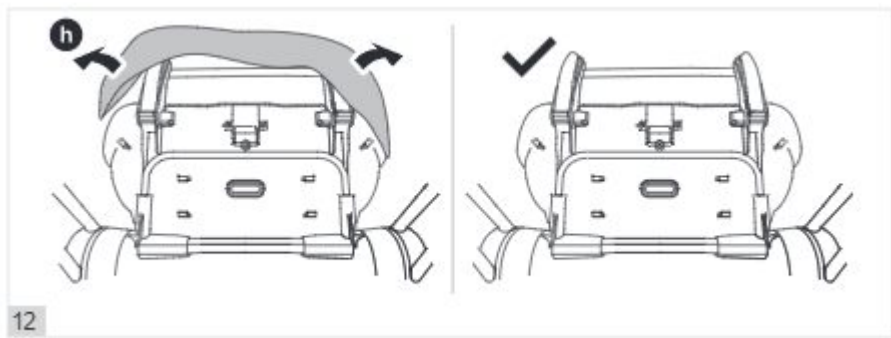

12



i

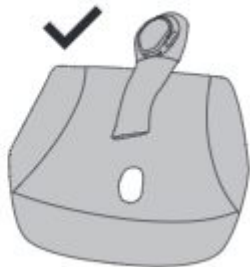

13





c

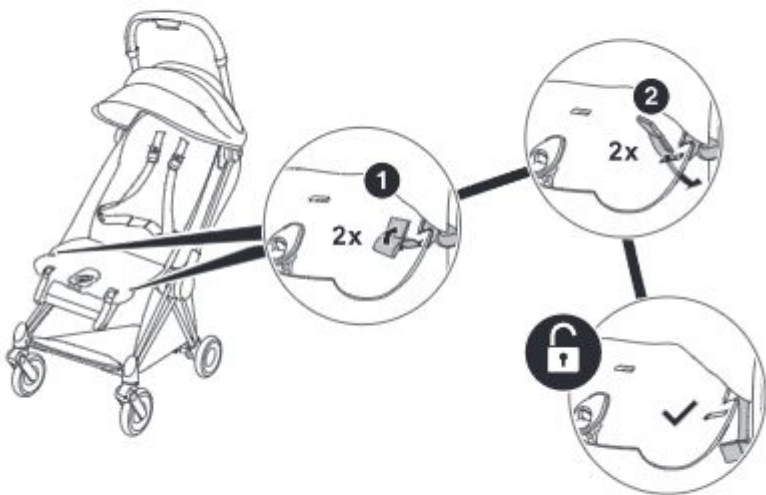



16

a



17

35

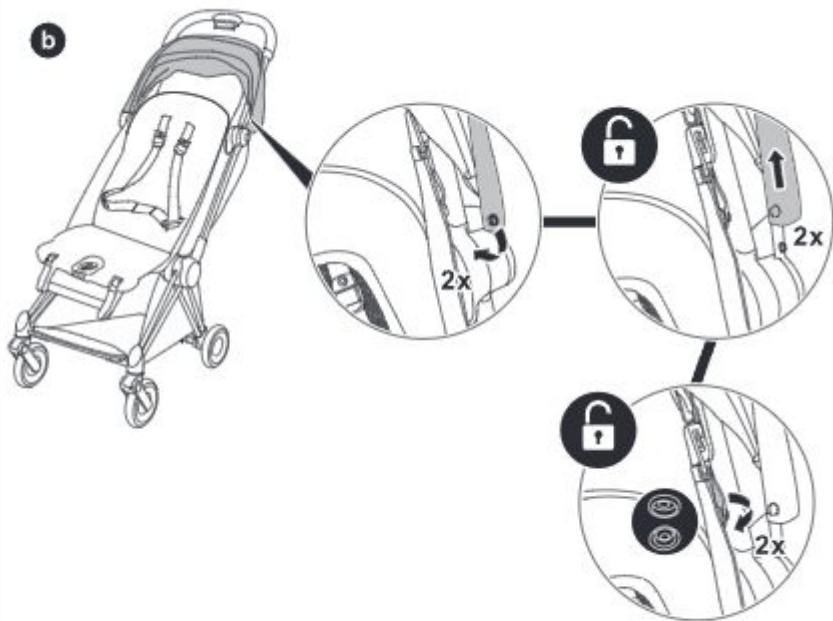

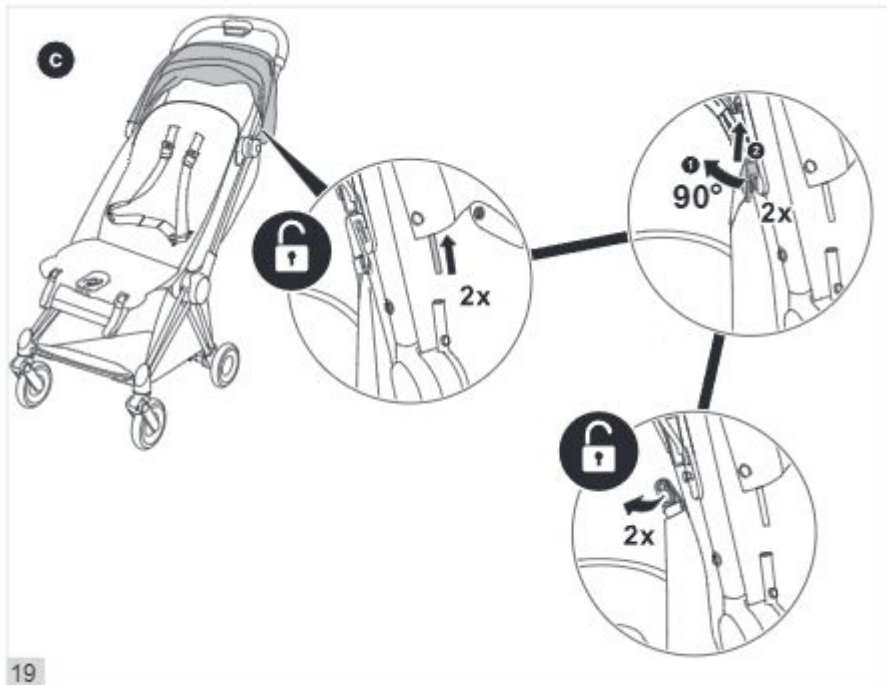



d

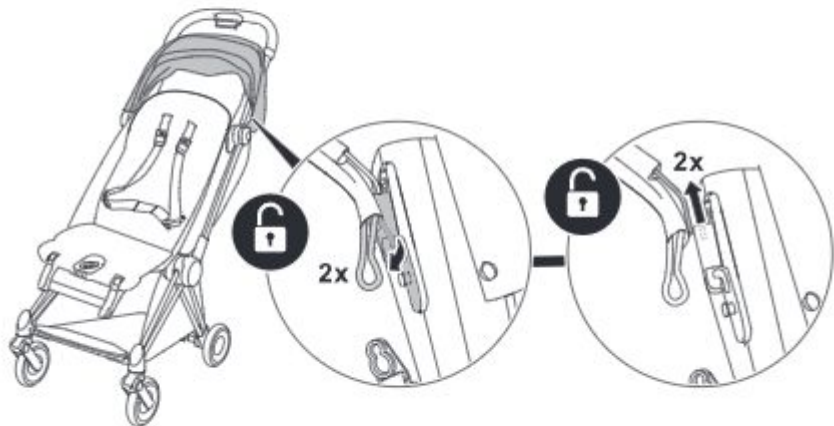



e

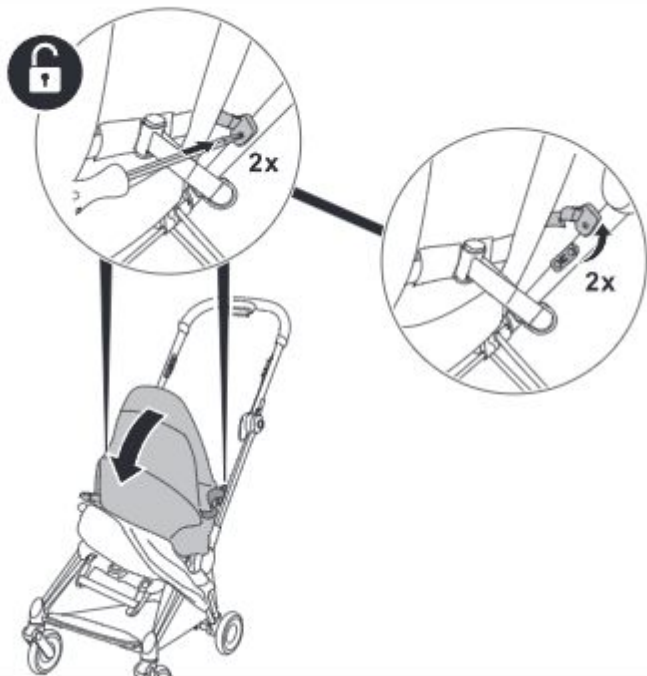

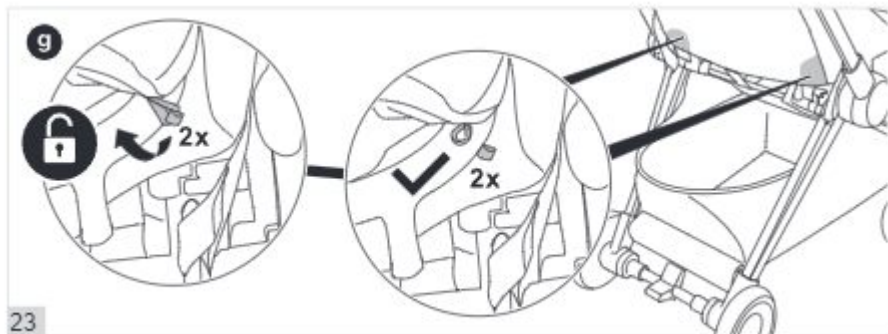
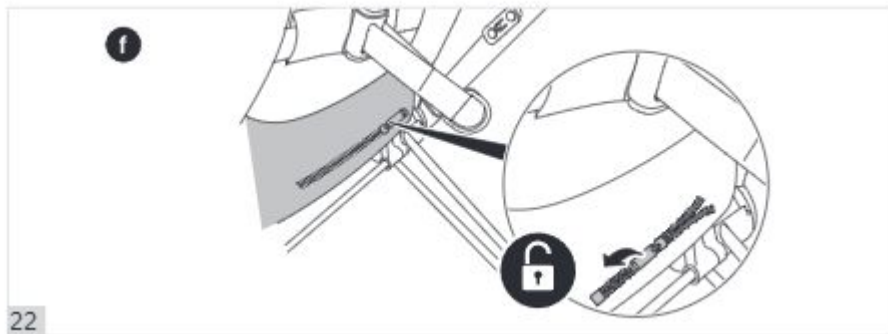

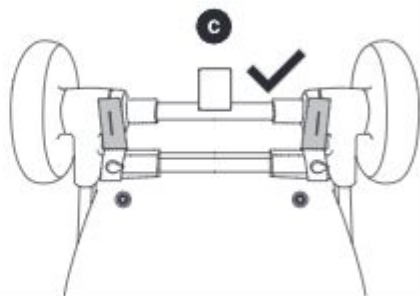
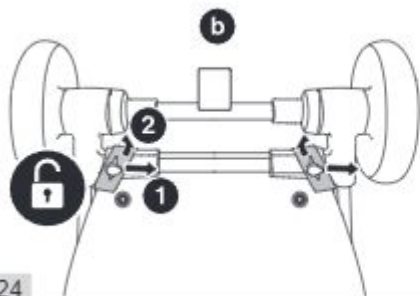
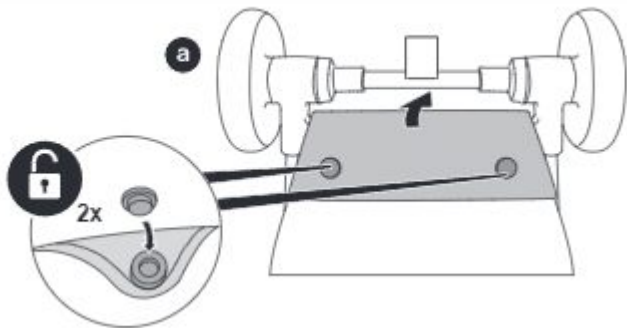



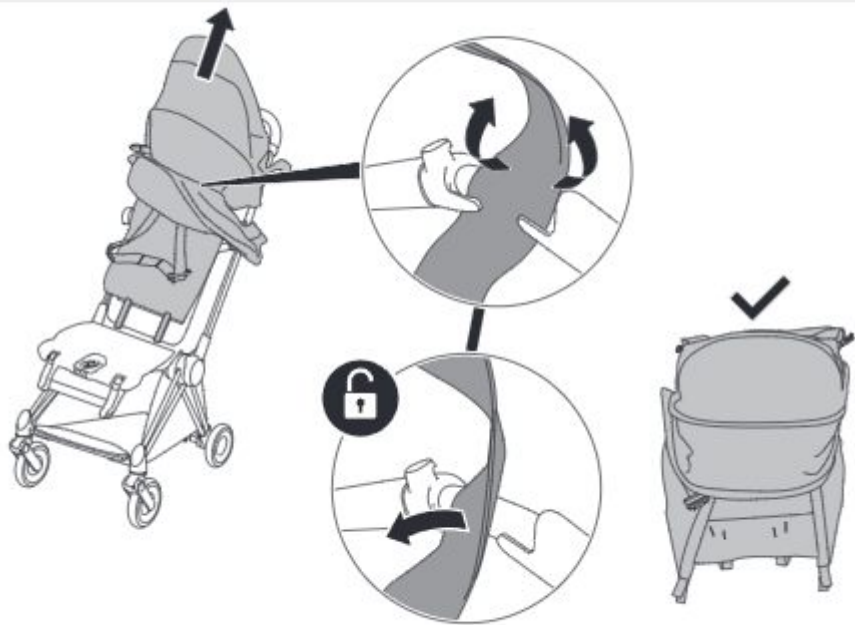

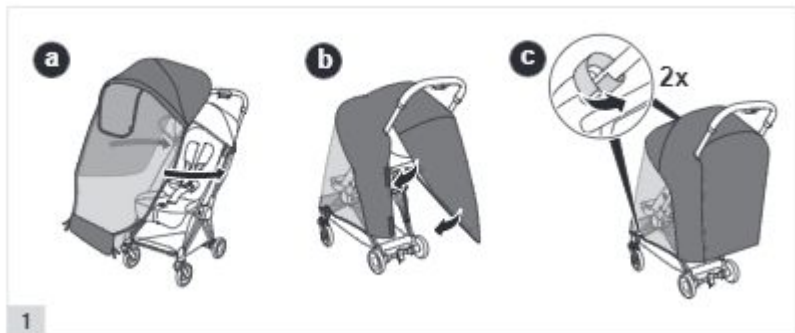

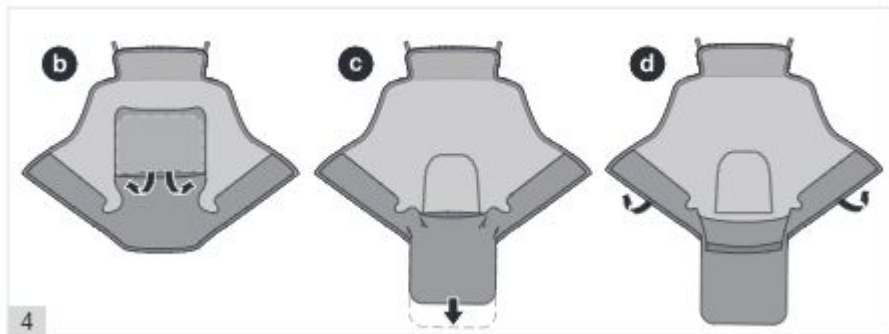



CYBEX GmbH
Riedingerstr. 18 | 95448 Bayreuth | Germany
+49 (0) 921-78 511-0 | info@cybex-online.com
www.cybex-online.com



FR

Cet appareil
et ses accessoires
se recyclent

REPRISE
À LA LIVRAISON



OU

À DÉPOSER
EN MAGASIN



OU

À DÉPOSER
EN DÉCHÈTRE

