

policy, there could be an extra charge for this service. Chelino will not take any responsibility if this product is incorrectly assembled thus causing any sort of injury to the user or the child. Alternatively you can contact Chelino directly on 0118352520, our offices hours are Monday to Thursday from 9:00 am to 13:00 pm and 14:00 to 16:30 pm and Fridays from 9:00 am to 12:00 pm and 14:00 pm to 16:30 pm. Our offices are closed on Saturdays, Sundays, Public holidays and for three weeks during the December/ January festive season. There is a charge for the assembly of any product. If you require a Chelino representative to assemble this product you will have to bring this product to our offices which are situated at 12 Kimberlite Road, Theta Ext, Booyens Reserve, 2091, Johannesburg, Gauteng, RSA.

6. Please note, that any repair which will need to be made to this product must be done at the Chelino workshop which is situated at 12 Kimberlite Road, Theta Ext, Booyens Reserve, 2091, Johannesburg, Gauteng, RSA. Our offices hours are Monday to Thursday from 9:00 am to 13:00 pm and 14:00 pm to 16:30 pm and Fridays from 9:00 am to 12:00 pm and 14:00 pm to 16:30 pm. Our offices are closed on Saturdays, Sundays, Public holidays and for three weeks during the December/ January festive season. We do not provide any loan/ courtesy products while your product has been sent in for repairs. Chelino requires 7 working days to repair any product, but this lead time may vary depending on the transportation of the product too and from yourself. Once the warranty card is detached from this product and once this product is used even if used once and if there is a fault, this product will need to be sent to the Chelino Workshop for the repair and no refund/credit/exchange will be allowed. Only a Chelino representative can decide whether the product needs to be replaced/credited/exchanged.

7. Once you are satisfied with the assembly of this product and have read this instruction and agree to the terms stated and are ready to use this product, please ensure that all safety locks are engaged to ensure safe use of this product.

8. Please ensure that the child is always securely strapped into this product at all times. The seat belts must be properly adjusted to keep the child secured. If the seat belt is too loose the child could fall out thus causing injury. If the seat belts are too tight it will cause injury and aggravation to the child.

9. Never leave the child unattended or without parent/guardian supervision while in this product, as injury could be caused by other parties intentionally or unintentionally. This product can be knocked over and the child can be injured.

10. Never lift this product while the child is in it. This can cause injury to the child seated in this product.

11. Never allow the child to stand on the seat of this product. This can cause this product to fold and thus causing injury to the child. The child can also fall out of this product causing injury to him/herself. This can also cause damage to structure of this product.

12. This product is designed for the use of only one child. This product cannot accommodate more than one child.

13. Take special care when adjusting the backrest if the child is seated in this product. It is preferred to select the desired backrest position before seating the child this product.

14. Front tray is there for convenience and are not suitable for holding large amounts of liquids (hot or cold) or heavy objects. These areas are also not waterproof or leak proof and spillage can occur.

15. This product is fit to carry a child weighing no more than 18kgs. It is suitable from 6 months (when child can sit by himself) to 6 years. It could be used as table after 3 years old.

16. Do not place this product near to a window or fire or heating equipment, it will cause danger.

17. Chelino takes no responsibility and will not be held liable for any damage or injury caused by using this product or if this product is used for any other purposes other than its intended purpose.

18. Please note, there are no warranties or guarantee on any fabrics or sponge grip handles used on this product.

### Warning

1. Do not use until your child can sit by himself.
2. Do not use if any parts are broken, attrited or missed.
3. Do not use until all spare parts are rightly assembled and adjusted.
4. It is extremely dangerous place the high chair near the fire, heating appliance, such as electric welding and gas heater. Do not do it.
5. Prevent serious injury or death from falls or sliding out. Always secure the child in the restraint. Never leave child unattended.

### Dimension info

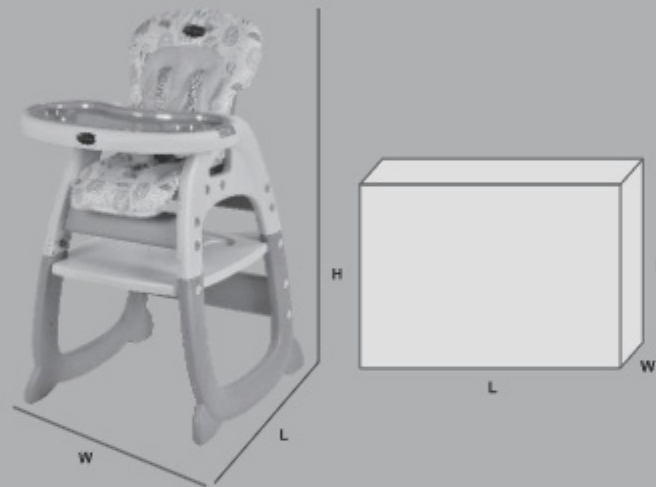

LENGTH	67 CM	CARTON LENGTH	65 CM
WIDTH	63 CM	CARTON WIDTH	27.5 CM
HEIGHT	107 CM	CARTON HEIGHT	54 CM
WEIGHT	7.6 KGS		

**ChelinoBaby**

Stores: ChelinoBaby – Ormonde – JHB  
 ChelinoBaby – Fourways – JHB  
 ChelinoBaby – Menlyn – Pretoria  
 ChelinoBaby – Gateway – Durban  
 ChelinoBaby – Online – www.chelinobaby.co.za



Importer: Anchor International  
 Add: 12 Kimberlite Road, Theta Ext 5 Booyens Reserve, JHB 2091 South Africa.  
 Tel: +2711 8352520  
 Info: info@chelino.co.za

**Chelino**

## ANGEL HIGH CHAIR USER'S MANUAL

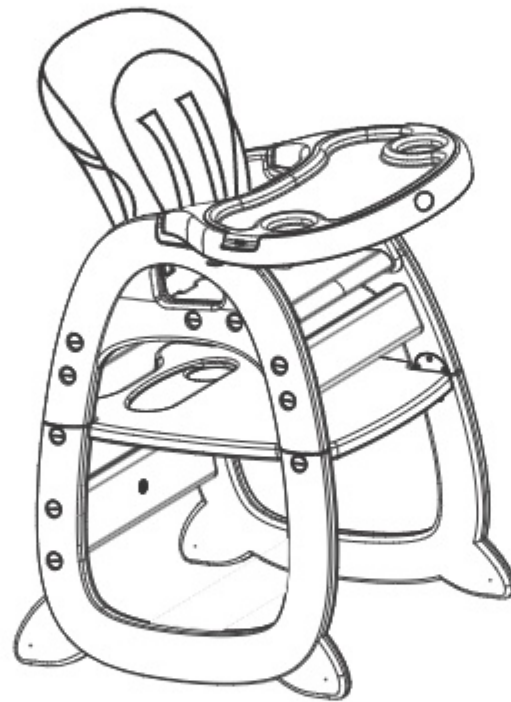

Jafim Imports CC T/A Anchor International  
 No. 12 Kimberlite Road, Theta Ext 5, Booyens Reserve, Johannesburg 2091, South Africa

+2711 835 2520  
 www.chelinobaby.co.za



### Instruction for Highchair

Important-Retain for future reference, read carefully  
 Suitable from 6 months to 6 years; less than 18kgs when the child could sit by himself.  
 It could be used as table after 3 years old.

### Major parts name:



### Installation instruction for Highchair

#### Assemble the backrest and booster

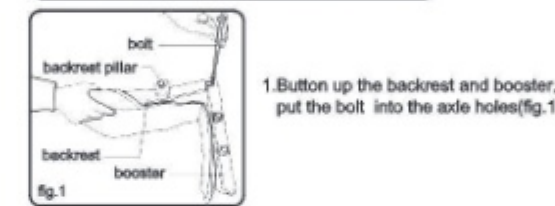

#### Assemble the booster & backrest and the armrest

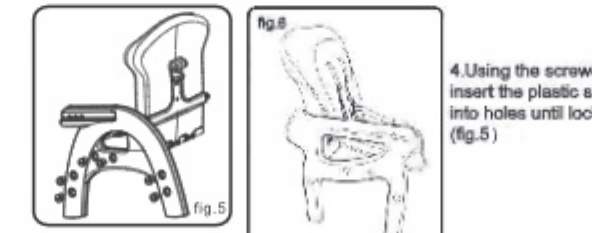
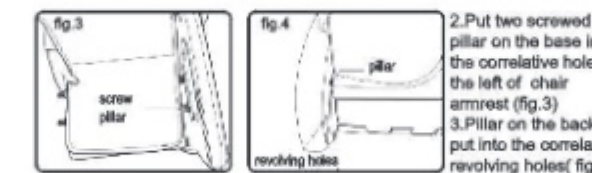
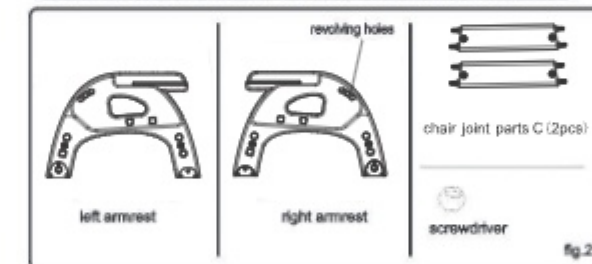

### Assemble the table

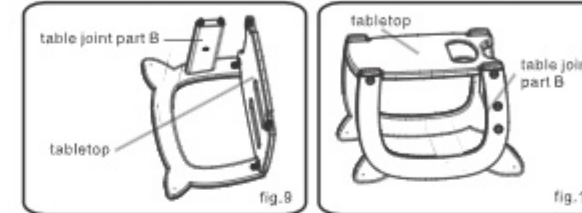
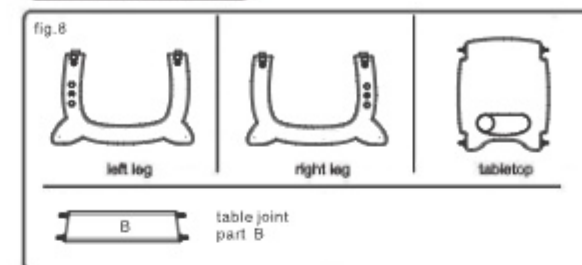

6. Insert tabletop, table joint part B into the correlative left or right holes (fig. 9&10)  
 And tighten the screws and locked

### Assemble the chair and table

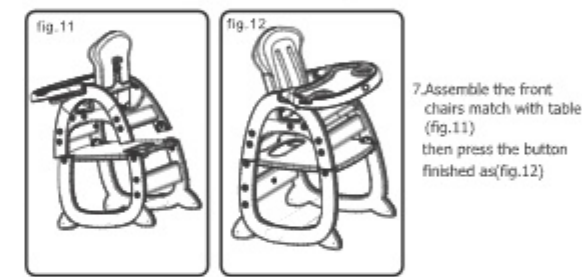

### Install and adjust the adjustable tray

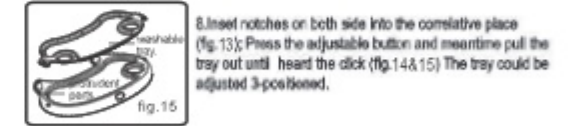
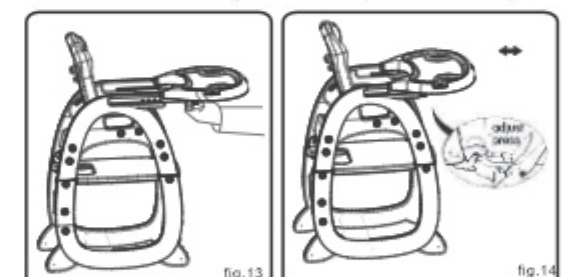

### Adjust the backrest

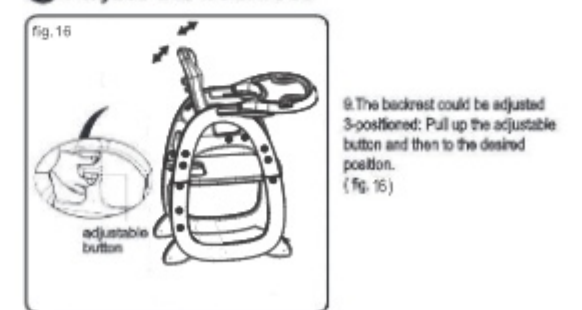

### Remove and discharge the cover

10. Press the oval button on the middle of buckle and open the buckle (fig. 17)  
 11. Press the button on the insert buckle side, and pull the belt out (fig. 18)  
 12. Pull out the belt from the button hole, then discharge the cover. (fig. 19-22)

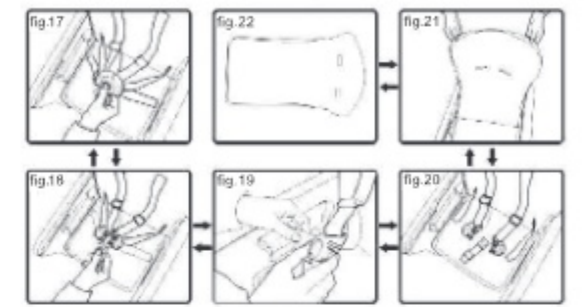

### Install table leg cover

13. Please make sure there are four different cover as D1, D2, D3, D4. Install each cover into the correlative position (fig. 23)



### Status when using as table and chair

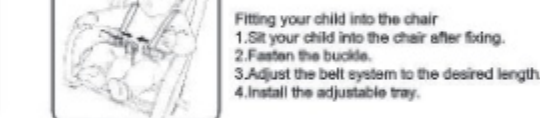
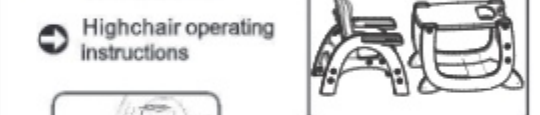

### SAFETY HINTS \ INSTRUCTIONS OF USE \ WARRANTY & GAURANTEE GUIDELINES

1. Please read this User Guide thoroughly before using this product. If you are not sure on any point in this guide please consult with the sales person whom sold you this product or contact Chelino on 0118352520. Our offices hours are Monday to Thursday from 9:00 am to 13:00 pm and 14:00 pm to 16:30 pm and Fridays from 9:00 am to 12:00 pm and 14:00 pm to 16:30 pm. Our offices are closed on Saturdays, Sundays, Public holidays and for three weeks during the December/ January festive season. We are situated at 12 Kimberlite Road, Theta Ext, Booyens Reserve, 2091, Johannesburg, Gauteng, RSA.
2. To avoid suffocation or swallowing or any other illness, please keep all packaging which have been removed from parts wrapped in the box away from infants, toddlers, children or any other living being. Please carefully dispose of the unwanted packaging once this product is fully assembled and you are satisfied with your purchase.
3. Please make sure that you are entirely satisfied with your purchase before removing the warning card attached to this product and before using this product. Once the warning card has been removed and if this product has been used we will not accept the return of this product.
4. If you are not entirely satisfied with this product purchased, please disassemble this product and re-pack it in the original packaging and return it to the store you purchased it from together with the proof of purchase. Depending on the stores policy, you will either be entitled to a replacement product, a credit voucher or a refund. This depends on the stores policies.
5. If you are not entirely satisfied with the assemble of this product or if you are not 100% sure that you have assembled this product correctly, please take this product back to the store you purchased it from and request for some assistance in checking if the assembly is correct or get this product assembled. Depending on the store's