

 cybex
GOLD

LIBELLE





EN WARNING
DE WARNUNG
ES ADVERTENCIA
FR AVERTISSEMENT
PT AVISOS
IT ATTENZIONE
NL WAARSCHUWING
PL OSTRZEŻENIE
CS UPOZORNĚNÍ
SK UPOZORNENIE
SL OPOZORILO
HR UPOZORENJE
HU FIGYELMEZTETÉS
SE VARNING
NO ADVARSEL
FI VAROITUS
DA ADVARSEL
ET HOIATUS
LV BRĪDINĀJUMS
LT PERSPĖJIMAS
RU ВНИМАНИЕ
UK УВАГА
TR UYARI
EL ΠΡΟΕΙΔΟΠΟΙΗΣΗ
RO AVERTISMENTE
IS VIDVÖRUN
MT TWISSUA

AR
FA
YUE 警告
CMN 警告
JA 警告
KO 경고
BG ПРЕДУПРЕЖДЕНИЕ
SR UPOZORENJE
MS AMARAN
HI चेतावनी
TH คำเตือน
SQ PARALAJMËRIM
BS UPOZORENJE
ME UPOZORENJE
MK ПРЕДУПРЕДУВАЊЕ
HY αληθείνη
VI CẢNH BÁO

تحذير
اخطار



EN Tutorial video
DE Videoanleitung
ES Tutorial en video
FR Vidéo de démonstration
PT Video tutorial
IT Video tutorial
NL Instructievideo
PL Film instruktażowy
CS Vyučové video
SK Vyučové video
SL Video z navodili
HR Video s uputama
HU Bemutatóvideo
SE Videosjällstudiekurs
NO Oppføringsvideo
FI Opetusvideo
DA Vejledende video
ET Õppevideo
LV Ar mācību video
LT Mokomasis vaizdo įrašas
RU Обучающее видео
UK Навчальне відео
TR Öğretici video
EL Εκπαιδευτικό βίντεο
RO Video tutorial
IS Kennslumyndband
MT Tutorial fuq vidjow

AR
FA
YUE 教程視頻
CMN 教程視頻
JA チュートリアルビデオ
KO 튜토리얼 동영상
BG Учебно видео
SR Video sa uputstvima
MS Video tutorial
HI क्यूटोरियल वीडियो
TH ideo hướnɡ dẫ
SQ Video udhëzuese
BS Video sa uputstvima
ME Video sa uputstvima
MK Видеоупатство
HY Παιδαγωγική βίντεο
VI Video hướng dẫn

فیدئو تدریسی
ویدئوی آموزشی



= 10

EN	Maximum weights	TR	Maksimum ağırlıklar
DE	Maximalgewichte	EL	Μέγιστο βάρος
ES	Pesos máximos	RO	Greutăți maxime
FR	Poids maximum	IS	Hámarksþyngd
PT	Pesos máximos	MT	Piżiżiet massimi
IT	Peso massimo	AR	الأوزان القصوى
NL	Maximumgewicht	FA	حداکثر وزن
PL	Dopuszczalna waga	YUE	最大重量
CS	Maximální hmotnosti	CMN	最大重量
SK	Maximálne hmotnosti	JA	最大重量
SL	Največje teže	KO	최대 하중
HR	Maksimalne težine	BG	Максимални тежга
HU	Maximalis súlyok	SR	Maksimalne težine
SE	Max.vikter	MS	Berat maksimum
NO	Maksimumsvektor	HI	सुविचरुतम वजन
FI	Enimmäispainot	TH	น้ำหนักสูงสุด
DA	Maksimumvægt	SQ	Peshat maksimale
ET	Maksimaalne kaal	BS	Maksimalne težine
LV	Maksimālais svars	ME	Maksimalne težine
LT	Didžiausi svoriai	MK	Максимални тежини
RU	Максимальная масса	HY	Ամալվելազույն քաշեր
UK	Максимальна вага	VI	Các mức cân nặng tối đa

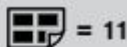

= 11

EN	Product registration	TR	Ürün kaydı
DE	Produktregistrierung	EL	Καταχώριση προϊόντος
ES	Registro del producto	RO	Înregistrarea produsului
FR	Enregistrement du produit	IS	Skráning tækis
PT	Registo do produto	MT	Registrazzjoni tal-prodott
IT	Registrazione del prodotto	AR	تسجيل المنتج
NL	Productregistratie	FA	ثبت محصول
PL	Rejestracja produktu	YUE	產品註冊
CS	Registrace výrobku	CMN	产品注册
SK	Registrácia výrobku	JA	製品の登録
SL	Registracija izdelka	KO	제품 등록
HR	Registracija proizvoda	BG	Регистрация на продукта
HU	Termékrejestráció	SR	Registracija proizvoda
SE	Produktregistrering	MS	Pendaftaran produk
NO	Produktregistrering	HI	उत्पाद पंजीकरण
FI	Tuotteen rekisteröinti	TH	การจดทะเบียนผลิตภัณฑ์
DA	Produktregistrering	SQ	Regjistrimi i produktit
ET	Toote registreerimine	BS	Registracija proizvoda
LV	Produkta registrācija	ME	Registracija proizvoda
LT	Gaminio registracija	MK	Регистрација на производ
RU	Регистрация продукта	HY	Արարարի արարումը
UK	Рєєєтрация продукту	VI	Đăng ký sản phẩm

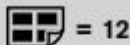

EN	Set up	TR	Kurulum
DE	Aufbau	EL	Στήσιμο
ES	Instalación	RO	Setare
FR	Montage	IS	Uppsetning
PT	Preparação	MT	Konfigurazzjoni
IT	Configurazione	AR	
NL	Opbouw	FA	تنصوب بهره کردن
PL	Montaż	YUE	設置
CS	Nastavení	CMN	设置
SK	Nastavenie	JA	セットアップ
SL	Nastavitev	KO	설정
HR	Postavljanje	BG	Настройка
HU	Felszerelés	SR	Postavljanje
SE	Inställning	MS	Persediaan
NO	Oppsett	HI	सेट अप
FI	Asetus	TH	การติดตั้ง
DA	Opsætning	SQ	Konfigurimi
ET	Seadistamine	BS	Postavljanje
LV	Uzstādīšana	ME	Postavljanje
LT	Nuostatos	MK	Поставување
RU	Установка	HY	Կարգադրում
UK	Встановлення	VI	Cài đặt



EN	Brake	TR	Fren
DE	Bremse	EL	Φρένο
ES	Freno	RO	Frână
FR	Frein	IS	Bremsa
PT	Bloqueio	MT	Brojok
IT	Freno	AR	
NL	Rem	FA	الدمكاج ترمز
PL	Hamulec	YUE	剎車
CS	Brzda	CMN	剎車
SK	Brzda	JA	ブレーキ
SL	Zavora	KO	브레이크
HR	Kočnica	BG	Спирачка
HU	Fék	SR	Kočnica
SE	Broms	MS	Brak
NO	Brems	HI	ब्रेक
FI	Jarru	TH	เบรก
DA	Bremse	SQ	Frenat
ET	Pidur	BS	Kočnica
LV	Bremze	ME	Kočnica
LT	Stabdys	MK	Спирачка
RU	Тормоза	HY	Արգելակ
UK	Гальма	VI	Phanh thắng



= 14

EN	Folding	TR	Katlama
DE	Faltung	EL	Ανοδίαλωση
ES	Plegado	RO	Pliere
FR	Pliant	IS	Brjóta saman
PT	Fecho	MT	Tiwi
IT	Ripiegamento	AR	
NL	Vouwen	FA	
PL	Składanie	YUE	折疊
CS	Skládání	CMN	折疊
SK	Zloženie	JA	折りたたみ
SL	Zlaganje	KO	접기
HR	Preklapanje	BG	Сгъване
HU	Összecukás	SR	Preklapanje
SE	Ihopfällning	MS	Lipat
NO	Sammonlogging	HI	फोड़ना
FI	Kokoon taittaminen	TH	การพับ
DA	Sammenklapning	SQ	Palosja
ET	Kokku voltimine	BS	Preklapanje
LV	Salocīšana	ME	Preklapanje
LT	Lankstymas	MK	Склопување
RU	Складывание	HY	Եսկայում
UK	Складання	VI	Gấp lại

قابلية للطي
تأكيرون

= 16

EN	Harness	TR	Emniyet kemeri
DE	Gurtsystem	EL	Συγκράτηση
ES	Arnés	RO	Centură
FR	Harnais	IS	Beisli
PT	Arnês	MT	Cinga tas-sigurtà
IT	Imbracatura	AR	حزام الأمان
NL	Harnas	FA	سیستم مهار
PL	Szelki	YUE	安全帶
CS	Popruh	CMN	安全帶
SK	Popruh	JA	安全ベルト
SL	Varnostni pas	KO	안전띠
HR	Sustav vezivanja	BG	Сбруя
HU	Biztonsági öv	SR	Sistem vezivanja
SE	Sole	MS	Abah-abah
NO	Beltsystem	HI	बचक
FI	Vyöjärjestelmä	TH	เชือกนิรภัย
DA	Solesystem	SQ	Pajimet
ET	Turvarihmad	BS	Sistem vezivanja
LV	Drošības josta	ME	Sistem vezivanja
LT	Diržai	MK	Сигурносен каиш
RU	Ремни безопасности	HY	Անդադրողի
UK	Ремінь	VI	Dây an toàn

 = 19

EN	Bumper bar	TR	Tampon çubuğu
DE	Schutzbügel	EL	Μπάρα διατάξης προστασίας
ES	Barra de seguridad	RO	Bară de protecție
FR	Barre de protection	IS	Þverbítí
PT	Barra de segurança	MT	Strixta tal-bumper
IT	Barra paraurti	AR	حارضة ممسح الصدمات
NL	Veiligheidsbeugel	FA	مهله ضربهگیر
PL	Pałak zabezpieczający	YUE	保險杠
CS	Dětské madlo	CMN	保險杠
SK	Detská ručka	JA	バンパー/ブー
SL	Varnostni lok	KO	범퍼 바
HR	Štitnik	BG	Броня
HU	Karfa	SR	Štitnik
SE	Stötfångare	MS	Bar bampar
NO	Fender	HI	इम्पर बार्
FI	Suojakaari	TH	เบาะกันชน
DA	Sikkerhedsbøjle	SQ	Shufra e parakolpiti
ET	Turvakaar	BS	Štitnik
LV	Aizsargloks	ME	Štitnik
LT	Amortizatoriaus strypas	MK	Одбојник
RU	Поручень	HU	Թափարգի
UK	Обм'ягувальний поручень	VI	Thanh chống va đập



 = 20

EN	Backrest	TR	Arkalık
DE	Rückenlehne	EL	Πλάτη
ES	Respaldo	RO	Spătar
FR	Dossier	IS	Bak
PT	Encosto de costas	MT	Serh id-dahar
IT	Schienale	AR	مسند الظهر
NL	Rugleuning	FA	پشتی
PL	Oparcie	YUE	靠背
CS	Opěradlo	CMN	靠背
SK	Operadlo	JA	背もたれ
SL	Naslonjalo	KO	등받이
HR	Naslon	BG	Облочнола
HU	Hattámla	SR	Naslon
SE	Ryggstöd	MS	Penyandar belakang
NO	Rygglene	HI	बकरीट
FI	Selkänoja	TH	เบาะนั่ง
DA	Ryggen	SQ	Mbështetësja e shpinës
ET	Seljatugi	BS	Naslon
LV	Atzveltne	ME	Naslon
LT	Nugaros atlošas	MK	Наслон за грб
RU	Спинка	HY	Թիկնախի
UK	Спінка	VI	Phần tựa lưng

 = 21

EN Logrest
DE Beinstütze
ES Reposapiés
FR Repose-pieds
PT Apoio de pernas
IT Poggiagambe
NL Beensteun
PL Podnózek
CS Opěrka nohou
SK Opierka nôh
SL Naslon za nogo
HR Naslon za nogo
HU Labtartó
SE Benstöd
NO Benstette
FI Jalokatuki
DA Benstette
ET Jalatugi
LV Kāju balsts
LT Kojų atrama
RU Подставка для ног
UK Опора для ніг

TR Bacak desteği
EL Στήριγμα ποδιών
RO Suport picior
IS Fótahvíla
MT Serh is-saqajn
AR مسند الساقين
FA چهارپایه
YUE 𨋖𨋖
CMN 𨋖𨋖
JA 足のせ
KO 다리받이
BG Подложка за крака
SR Naslon za nogo
MS Tempat letak kaki
HI पैरों के टुकटा
TH ที่นั่งเท้า
SQ Mbështetësja e këmbëve
BS Naslon za nogo
ME Naslon za nogo
MK Наслон за нозе
HY Լսողորդի հիմնական կետ
VI Phàn tựa chân

 = 22

EN Removing the wheels
DE Entfernen der Räder
ES Quitar las ruedas
FR Retrait des roues
PT Remover as rodas
IT Rimozione delle ruote
NL De wielen verwijderen
PL Zdejmowanie kolek
CS Odstranění koloček
SK Odstránenie koliesok
SL Odstranjevanje koles
HR Uklanjanje kotača
HU Kerekék eltávolítása
SE Ta bort hjulen
NO Fjerne hjulene
FI Pyörien poisto
DA Fjernelse af hjulene
ET Rataste eemaldamine
LV Riteņu atvienošana
LT Ratų nuėmimas
RU Снятие колес
UK Зняття коліс

TR Tekerlekleri çıkarma
EL Αφαίρεση των τροχών
RO Îndepărtarea roților
IS Fjarlægginga hjól
MT Tnehhija tar-roti
AR فك العجلات
FA باز کردن چرخها
YUE 拆架車輪
CMN 拆架車輪
JA 車輪の取り外し
KO 휠 제거
BG Демонтиране на колелата
SR Uklanjanje točkova
MS Menanggalkan roda
HI पहियों को हटाना
TH ถอดล้อ
SQ Heqja e rrotave
BS Uklanjanje točkova
ME Uklanjanje točkova
MK Отстранување на тркалата
HY Անխլուցորդ հանելը
VI Tháo bánh xe



= 23

EN Removing the fabric	TR Kılıf çıkarma
DE Entfernen des Bezuges	EL Αφαίρεση του υφάσματος
ES Quitar la tela	RO Îndepărtarea țesăturii
FR Retrait du tissu	IS Fjarlægginga efni
PT Remover o tecido	MT Tnehhija tad-drapp
IT Rimozione del tessuto	AR إزالة القماش
NL De stof verwijderen	FA برداشتن پارچه
PL Zdejmowanie pokrycia	YUE 拆除篷布
CS Odstranění látky	CMN 拆除篷布
SK Odstránenie látky	JA 力/刀の取り外し
SL Odstranjevanje blaga	KO 피복을 제거
HR Uklanjanje tkanine	BG Демонтиране на плато
HU Huzat eltávolítása	SR Uklanjanje tkanine
SE Ta bort tygget	MS Menanggalkan fabrik
NO Fjerne stoffet	HI रूपड़ा हटाना
FI Kankaan poisto	TH 拆除帆布
DA Fjernelse af stoffet	SQ Heqja e copës
ET Kanga eemaldamine	BS Uklanjanje tkanine
LV Pārklājuma atvienošana	ME Uklanjanje tkanine
LT Audinio nuėmimas	MK Отстранување на навлаката
RU Снятие ткани	HY Գործվածքը հանելը
UK Зняття матерії	VI Tháo phần vải bọc



= 28

EN Rain cover	TR Yağmurluk
DE Regenwerdeck	EL Καλύπτρα βροχής
ES Funda para la lluvia	RO Prelată de ploaie
FR Housse de pluie	IS Regn yfirbroiðsla
PT Capa de chuva	MT Ghata mix-sita
IT Parapioggia	AR غطاء المطر
NL Regenhoes	FA روکش باران
PL Osłona od deszczu	YUE 防雨罩
CS Plaštánka	CMN 防雨罩
SK Kryt proti dažďu	JA 雨ふけ
SL Dožna prevleka	KO 레인커버
HR Pokrivač za kišu	BG Дъждобран
HU Esővédő	SR Pokrivač za kišu
SE Regnskydd	MS Pelindung hujan
NO Kalose	HI रैन कवर
FI Sadesuoja	TH ฝนกันแดด
DA Regnslag	SQ Mbulesë për shiun
ET Vihmakate	BS Pokrivač za kišu
LV Pretlietus pārvalks	ME Pokrivač za kišu
LT Uždangalas nuo lietaus	MK Прекривка за дожд
RU Дождовин	HY Անձրևապաշտպան ծածկ
UK Дошовин	VI Tấm che mưa



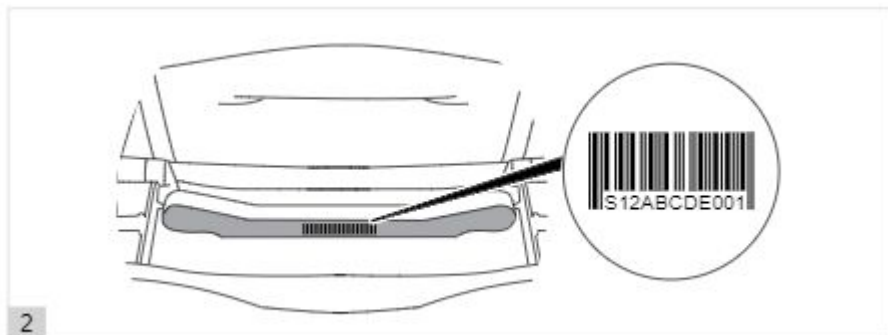
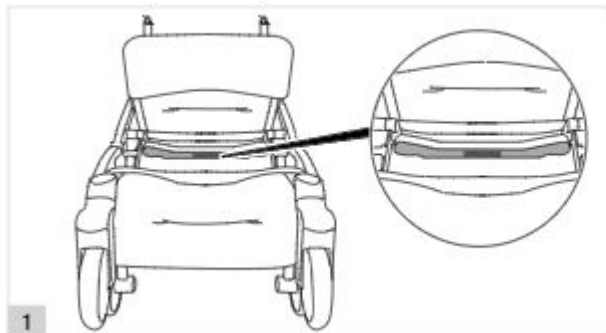



1

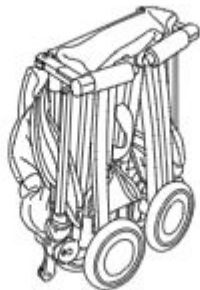

optional



optional



optional



12

2

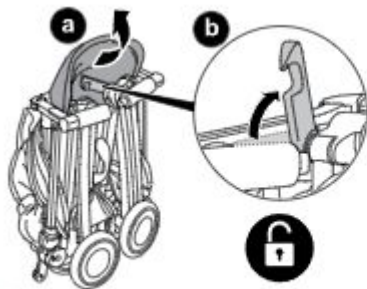

3





4

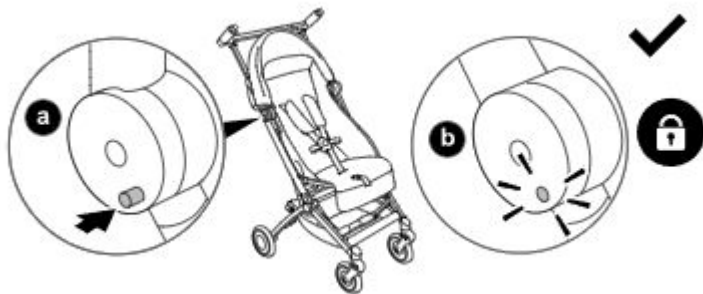

5



1

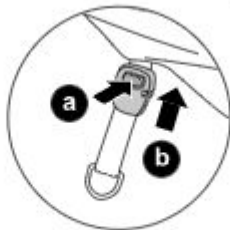
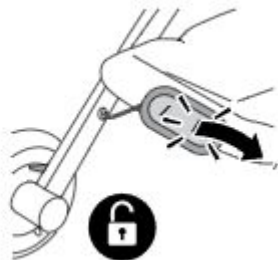

1

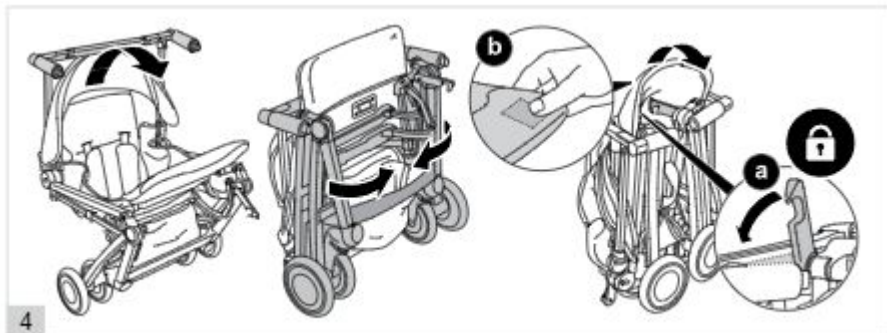
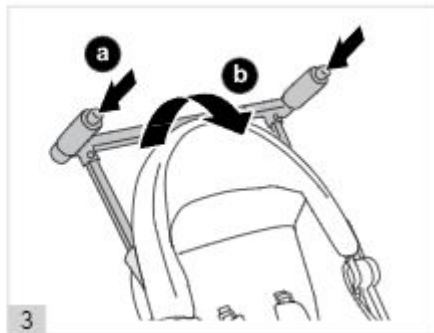

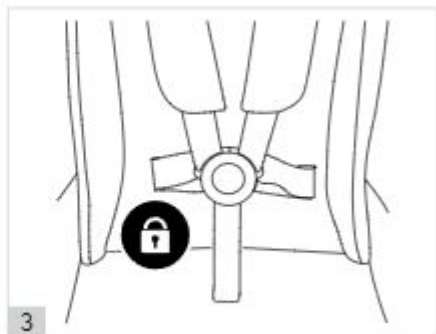
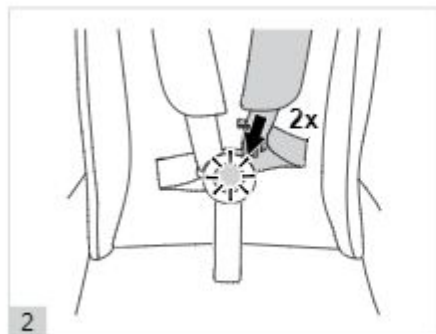
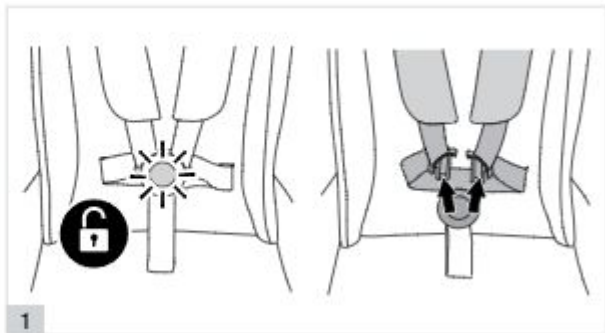

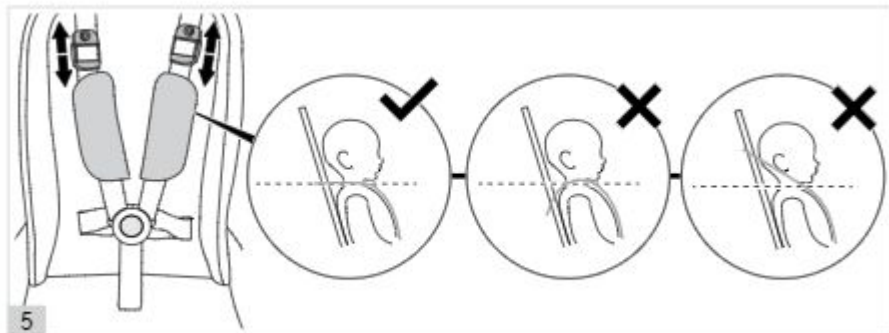
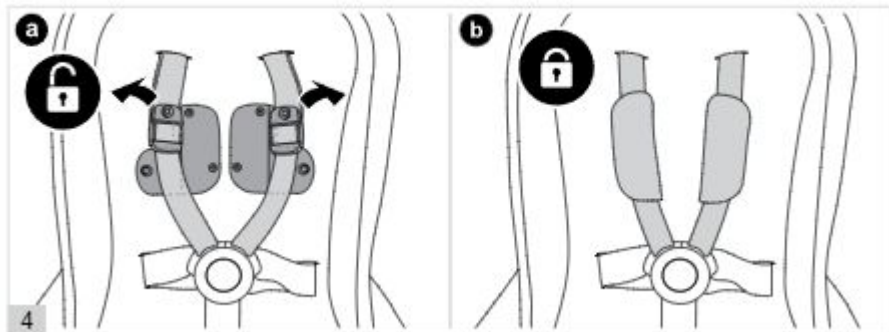

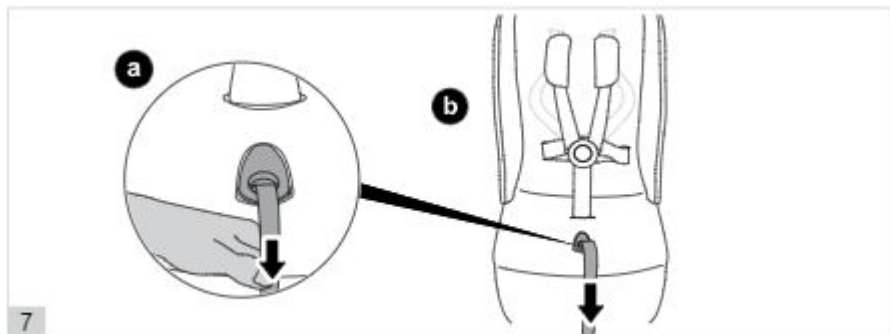
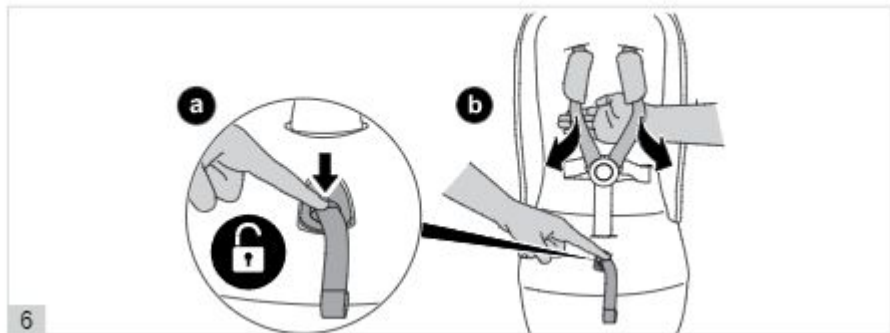

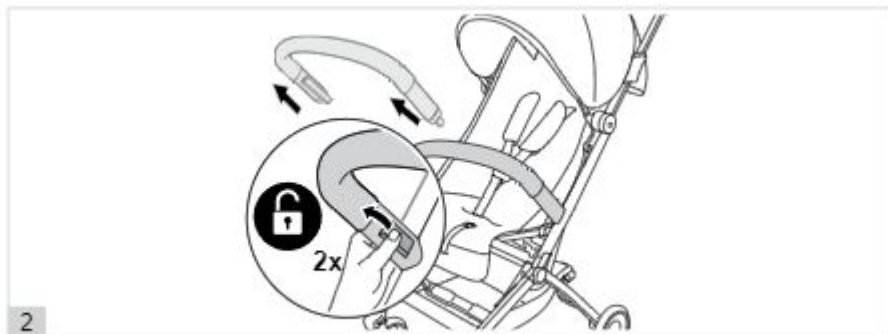
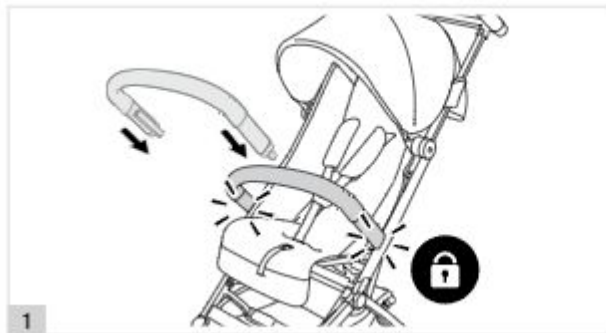

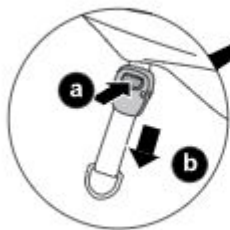

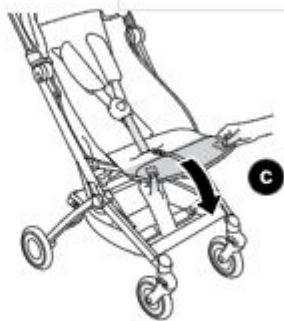

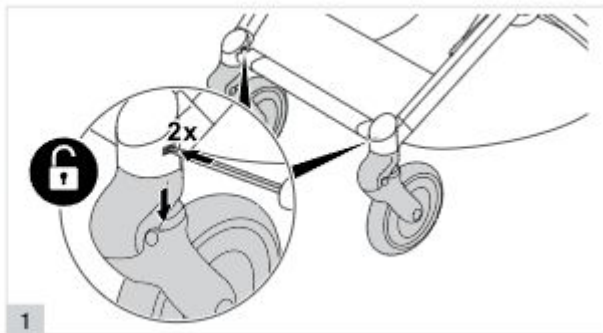

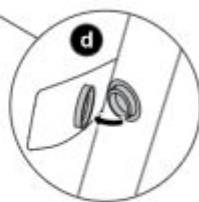
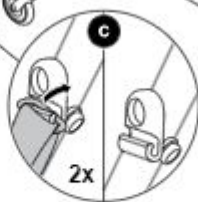
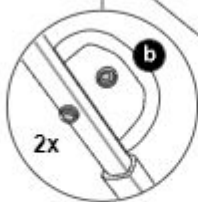
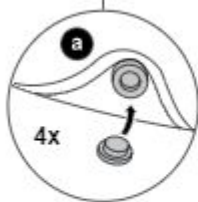

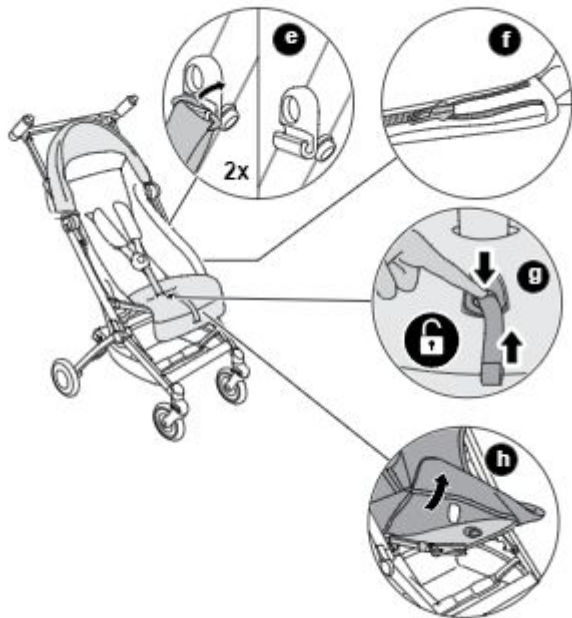

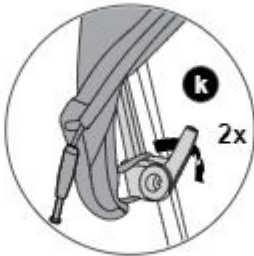
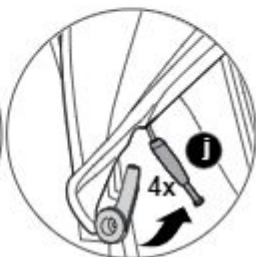
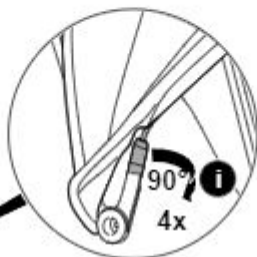
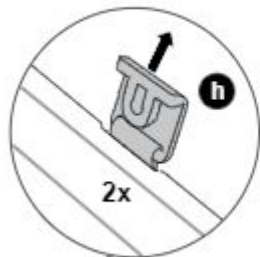

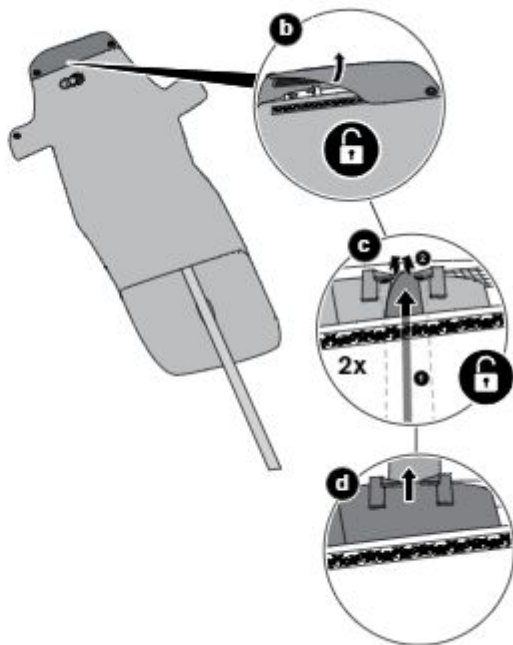
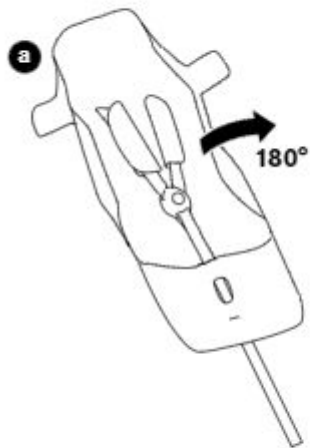

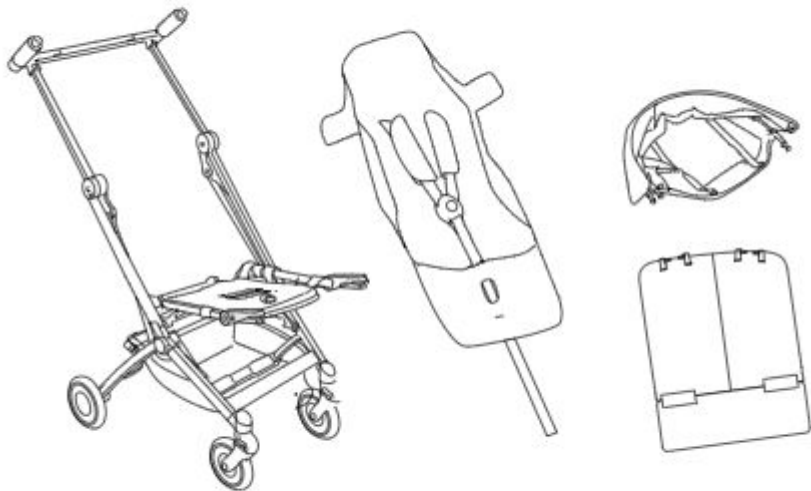



optional



a





2



CYBEX GmbH
Riedingerstr. 18 | 95448 Bayreuth | Germany
+49 (0) 921-78 511-0 | info@cybex-online.com
www.cybex-online.com

 cybex



Points de collecte sur www.quefairede mesdechets.fr