

 **cybex**
GOLD

LIBELLE





EN WARNING
DE WARNUNG
ES ADVERTENCIA
FR AVERTISSEMENT
PT AVISOS
IT ATTENZIONE
NL WAARSCHUWING
PL OSTRZEŻENIE
CS UPOZORNĚNÍ
SK UPOZORNENIE
SL OPOZORILO
HR UPOZORENJE
HU FIGYELMEZTETÉS
SE VARNING
NO ADVARSEL
FI VAROITUS
DA ADVARSEL
ET HOIATUS
LV BRĪDINĀJUMS
LT PERSPĖJIMAS
RU ВНИМАНИЕ
UK УВАГА
TR UYARI
EL ΠΡΟΕΙΔΟΠΟΙΗΣΗ
RO AVERTISMENTE
IS VIÐVÖRUN
MT TWISSIJA

AR
FA
YUE 警告
CMN 警告
JA 警告
KO 경고
BG ПРЕДУПРЕЖДЕНИЕ
SR UPOZORENJE
MS AMARAN
HI चेतावनी
TH คำเตือน
SQ PARALAJMËRIM
BS UPOZORENJE
ME UPOZORENJE
MK ПРЕДУПРЕДУВАЊЕ
HY ՉԳՈՒՇԱՑՈՒՄ
VI CẢNH BÁO

تحذير
اخطار



EN Tutorial video
DE Videoanleitung
ES Tutorial en vídeo
FR Vidéo de démonstration
PT Video tutorial
IT Video tutorial
NL Instructievideo
PL Film instruktażowy
CS Výukové video
SK Výukové video
SL Video z navodili
HR Video s uputama
HU Bemutatóvideó
SE Videosjälvstudiekurs
NO Opplæringsvideo
FI Opetusvideo
DA Vejledende video
ET Õppevideo
LV Arpmācību video
LT Mokomasis vaizdo įrašas
RU Обучающее видео
UK Навчальне відео
TR Öğretici video
EL Εκπαιδευτικό βίντεο
RO Video tutorial
IS Kennslumyndband
MT Tutorial fuq vidjow

AR
FA
YUE 教程視頻
CMN 教程视频
JA チュートリアルビデオ
KO 튜토리얼 동영상
BG Учебно видео
SR Video sa uputstvima
MS Video tutorial
HI ट्यूटोरियल वीडियो
TH วิดีโอแนะนำ
SQ Video udhëzuese
BS Video sa uputstvima
ME Video sa uputstvima
MK Видеоупатство
HY Παιδαγωγικά βίντεο
VI Video hướng dẫn

فيديو تعليمي
ويدئوى آموزشى

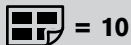

EN Maximum weights
DE Maximalgewichte
ES Pesos máximos
FR Poids maximum
PT Pesos máximos
IT Peso massimo
NL Maximumgewicht
PL Dopuszczalna waga
CS Maximální hmotnosti
SK Maximálne hmotnosti
SL Največje teže
HR Maksimalne težine
HU Maximális súlyok
SE Max.vikter
NO Maksimumsvektor
FI Enimmäispainot
DA Maksimumvægt
ET Maksimaalne kaal
LV Maksimālais svars
LT Didžiausi svoriai
RU Максимальная масса
UK Максимальна вага

TR Maksimum ağırlıklar
EL Μέγιστο βάρος
RO Greutăți maxime
IS Hámarksþyngd
MT Piżijiet massimi
AR الأوزان القصوى
FA حداکثر وزن
YUE 最大重量
CMN 最大重量
JA 最大重量
KO 최대 하중
BG Максимални тегла
SR Maksimalne težine
MS Berat maksimum
HI अधिकतम बजन
TH น้ำหนักสูงสุด
SQ Peshat maksimale
BS Maksimalne težine
ME Maksimalne težine
MK Максимални тежини
HY Առավելագույն քաշեր
VI Các mức cân nặng tối đa

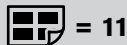

EN Product registration
DE Produktregistrierung
ES Registro del producto
FR Enregistrement du produit
PT Registo do produto
IT Registrazione del prodotto
NL Productregistratie
PL Rejestracja produktu
CS Registrace výrobku
SK Registrácia výrobku
SL Registracija izdelka
HR Registracija proizvoda
HU Termékregisztráció
SE Produktregistrering
NO Produktregistrering
FI Tuotteen rekisteröinti
DA Produktregistrering
ET Toote registreerimine
LV Produkta reģistrācija
LT Gaminio registracija
RU Регистрация продукта
UK Реєстрація продукту

TR Ürün kaydı
EL Καταχώριση προϊόντος
RO Înregistrarea produsului
IS Skráning tækis
MT Reġistrazzjoni tal-prodott
AR تسجيل المنتج
FA ثبت محصول
YUE 產品註冊
CMN 产品注册
JA 製品の登録
KO 제품 등록
BG Регистрация на продукта
SR Registracija proizvoda
MS Pendaftaran produk
HI उत्पाद पंजीकरण
TH การลงทะเบียนผลิตภัณฑ์
SQ Regjistrimi i produktit
BS Registracija proizvoda
ME Registracija proizvoda
MK Регистрација на производ
HY Արձարանքի գրանցում
VI Đăng ký sản phẩm



= 12

EN	Set up	TR	Kurulum
DE	Aufbau	EL	Στήσιμο
ES	Instalación	RO	Setare
FR	Montage	IS	Uppsetning
PT	Preparação	MT	Konfigurazzjoni
IT	Configurazione	AR	تنصيب
NL	Opbouw	FA	برپا کردن
PL	Montaż	YUE	設置
CS	Nastavení	CMN	设置
SK	Nastavenie	JA	セットアップ
SL	Nastavitev	KO	설정
HR	Postavljanje	BG	Настройка
HU	Felszerelés	SR	Postavljanje
SE	Inställning	MS	Persediaan
NO	Oppsett	HI	सेट अप
FI	Asennus	TH	การติดตั้ง
DA	Opsætning	SQ	Konfigurimi
ET	Seadistamine	BS	Postavljanje
LV	Uzstādīšana	ME	Postavljanje
LT	Nuostatos	MK	Поставување
RU	Установка	HY	Շարժափոխում
UK	Встановлення	VI	Cài đặt



= 14

EN	Brake	TR	Fren
DE	Bremse	EL	Φρένα
ES	Freno	RO	Frână
FR	Frein	IS	Bremsa
PT	Bloqueio	MT	Brejik
IT	Freno	AR	المكابح
NL	Rem	FA	ترمز
PL	Hamulec	YUE	剎車
CS	Brzda	CMN	刹车
SK	Brzda	JA	ブレーキ
SL	Zavora	KO	브레이크
HR	Kočnica	BG	Спирачка
HU	Fék	SR	Kočnica
SE	Broms	MS	Brek
NO	Brems	HI	ब्रेक
FI	Jarru	TH	เบรค
DA	Bremse	SQ	Frenat
ET	Pidur	BS	Kočnica
LV	Bremze	ME	Kočnica
LT	Stabdys	MK	Сопирачка
RU	Тормоза	HY	Արգելակ
UK	Гальма	VI	Phanh thắng



 = 14

EN	Folding	TR	Katlama
DE	Faltung	EL	Αναδίπλωση
ES	Plegado	RO	Pliere
FR	Pliant	IS	Brjóta saman
PT	Fecho	MT	Tiwi
IT	Ripiegamento	AR	
NL	Vouwen	FA	
PL	Składanie	YUE	折疊
CS	Skládání	CMN	折疊
SK	Zloženie	JA	折りたたみ
SL	Zlaganje	KO	접기
HR	Preklapanje	BG	Сгъване
HU	Összecsukás	SR	Preklapanje
SE	Ihopfällning	MS	Lipat
NO	Sammenlegging	HI	फोल्डिंग
FI	Kokoon taittaminen	TH	การพับ
DA	Sammenklapning	SQ	Palosja
ET	Kokkuvoltimine	BS	Preklapanje
LV	Salocīšana	ME	Preklapanje
LT	Lankstymas	MK	Склопување
RU	Складывание	HY	Ծախելը
UK	Складання	VI	Gập lại

قابلية للطي
تا کردن



 = 16

EN	Harness	TR	Emniyet kemeri
DE	Gurtsystem	EL	Συγκράτηση
ES	Arnés	RO	Centură
FR	Harnais	IS	Beisli
PT	Arnês	MT	Ċinga tas-sigurtà
IT	Imbracatura	AR	طقم الشد
NL	Harnas	FA	سیدستم مهار
PL	Szelki	YUE	安全帶
CS	Popruh	CMN	安全帶
SK	Popruh	JA	安全ベルト
SL	Varnostni pas	KO	하네스
HR	Sustav vezivanja	BG	Сбруя
HU	Biztonsági öv	SR	Sistem vezivanja
SE	Sele	MS	Abah-abah
NO	Beltesystem	HI	कबच
FI	Vyöjärjestelmä	TH	ระบบสายรัด
DA	Selesystem	SQ	Pajimet
ET	Turvarihmad	BS	Sistem vezivanja
LV	Drošības josta	ME	Sistem vezivanja
LT	Diržai	MK	Сигурносен каиш
RU	Ремни безопасности	HY	Ամրագրուի
UK	Ремінь	VI	Dây an toàn



 = 19

EN	Bumper bar	TR	Tampon çubuğu
DE	Schutzbügel	EL	Μπάρα διατάξης προστασίας
ES	Barra de seguridad	RO	Bară de protecție
FR	Barre de protection	IS	Pverbiti
PT	Barra de segurança	MT	Strixxa tal-bumper
IT	Barra paraurti	AR	عارضة ممتص الصدمات
NL	Veiligheidsbeugel	FA	میله ضربهگیر
PL	Pałak zabezpieczający	YUE	保險杠
CS	Dětské madlo	CMN	保險杠
SK	Detská rúčka	JA	バンパーバー
SL	Varnostni lok	KO	범퍼 바
HR	Štitnik	BG	Броня
HU	Karfa	SR	Štitnik
SE	Stötfångare	MS	Bar bumper
NO	Fender	HI	बम्पर बार
FI	Suojakaari	TH	แถบกันชน
DA	Sikkerhedsbøjle	SQ	Shufra e parakolpit
ET	Turvakaar	BS	Štitnik
LV	Aizsargloks	ME	Štitnik
LT	Amortizatoriaus strypas	MK	Одбојник
RU	Поручень	HY	Թափարգել
UK	Обмежувальний поручень	VI	Thanh chống va đập



 = 20

EN	Backrest	TR	Arkalık
DE	Rückenlehne	EL	Πλάτη
ES	Respaldo	RO	Spătar
FR	Dossier	IS	Bak
PT	Encosto de costas	MT	Serħ id-dahar
IT	Schienale	AR	ممسد الظهر
NL	Rugleuning	FA	پشتی
PL	Oparcie	YUE	靠背
CS	Opěradlo	CMN	靠背
SK	Operadlo	JA	背もたれ
SL	Naslonjalo	KO	등받이
HR	Naslon	BG	Облегалка
HU	Háttámla	SR	Naslon
SE	Ryggstöd	MS	Penyandar belakang
NO	Rygglene	HI	बैकरोस्ट
FI	Selkänoja	TH	พนักพิง
DA	Ryglæn	SQ	Mbështetësja e shpinës
ET	Seljatugi	BS	Naslon
LV	Atzveltne	ME	Naslon
LT	Nugaros atlošas	MK	Наслон за грб
RU	Спинка	HY	Թիկնալ
UK	Спинка	VI	Phần tựa lưng



 = 21

EN Legrest
DE Beinstütze
ES Reposapiés
FR Repose-pieds
PT Apoio de pernas
IT Poggiagambe
NL Beensteun
PL Podnózek
CS Opěrka nohou
SK Opierka nôh
SL Naslon za noge
HR Naslon za noge
HU Lábtartó
SE Benstöd
NO Benstøtte
FI Jalkatuki
DA Benstøtte
ET Jalatugi
LV Kāju balsts
LT Kojų atrama
RU Подставка для ног
UK Опора для ніг

TR Bacak desteği
EL Στήριγμα ποδιών
RO Suport picior
IS Fótahvíla
MT Serħ is-saqajn
AR مسند الساق
FA جا پای
YUE 腿托
CMN 腿托
JA 足のせ
KO 다리받이
BG Подложка за крака
SR Naslon za noge
MS Tempat letak kaki
HI लेगरेस्ट
TH ที่วางขา
SQ Mbështetësja e këmbëve
BS Naslon za noge
ME Naslon za noge
MK Наслон за нозе
HY Ուղեքրի հեւման կէտ
VI Phần tựa chân



 = 22

EN Removing the wheels
DE Entfernen der Räder
ES Quitar las ruedas
FR Retrait des roues
PT Remover as rodas
IT Rimozione delle ruote
NL De wielen verwijderen
PL Zdejmowanie kółek
CS Odstranění koleček
SK Odstránenie koliesok
SL Odstranjevanje koles
HR Uklanjanje kotača
HU Kerekek eltávolítása
SE Ta bort hjulen
NO Fjerne hjulene
FI Pyörien poisto
DA Fjernelse af hjulene
ET Rataste eemaldamine
LV Riteņu atvienošana
LT Ratų nuėmimas
RU Снятие колес
UK Зняття коліс

TR Tekerlekleri çıkarma
EL Αφαίρεση των τροχών
RO Îndepărtarea roților
IS Fjarlægja hjól
MT Tneħhija tar-roti
AR فك العجلات
FA باز کردن چرخها
YUE 拆卸車輪
CMN 拆卸车轮
JA 車輪の取り外し
KO 휠 제거
BG Демонтиране на колелата
SR Uklanjanje točkova
MS Menanggalkan roda
HI पहियों को हटाना
TH การถอดล้อ
SQ Heqja e rrotave
BS Uklanjanje točkova
ME Uklanjanje točkova
MK Отстранување на тркалата
HY Անխլնէրը հաւնէլը
VI Tháo bánh xe



 = 23

EN	Removing the fabric	TR	Kılıfı çıkarma
DE	Entfernen des Bezuges	EL	Αφαίρεση του υφάσματος
ES	Quitar la tela	RO	Îndepărtarea țesăturii
FR	Retrait du tissu	IS	Fjarlægja efni
PT	Remover o tecido	MT	Tneħħija tad-drapp
IT	Rimozione del tessuto	AR	فك القماش
NL	De stof verwijderen	FA	برداشتن پارچه
PL	Zdejmowanie pokrycia	YUE	拆除罩布
CS	Odstranění látky	CMN	拆除罩布
SK	Odstránenie látky	JA	カバーの取り外し
SL	Odstranjevanje blaga	KO	페브릭 제거
HR	Uklanjanje tkanine	BG	Демонтиране на плата
HU	Huzat eltávolítása	SR	Uklanjanje tkanine
SE	Ta bort tyget	MS	Menanggalkan fabrik
NO	Fjerne stoffet	HI	कपड़ा हटाना
FI	Kankaan poisto	TH	การถอดผ้า
DA	Fjernelse af stoffet	SQ	Heqja e copës
ET	Kanga eemaldamine	BS	Uklanjanje tkanine
LV	Pārkļājuma atvienošana	ME	Uklanjanje tkanine
LT	Audinio nuėmimas	MK	Отстранување на навлаката
RU	Снятие ткани	HY	Գործվածքը հանելը
UK	Зняття матерії	VI	Tháo phần vải bọc



 = 28

EN	Rain cover	TR	Yağmurluk
DE	Regenverdeck	EL	Καλύπτρα βροχής
ES	Funda para la lluvia	RO	Prelată de ploaie
FR	Housse de pluie	IS	Regn yfirbreiðsla
PT	Capa de chuva	MT	Għata mix-xita
IT	Parapioggia	AR	غطاء المطر
NL	Regenhoes	FA	روکش باران
PL	Oslona od deszczu	YUE	防雨罩
CS	Pláštěnka	CMN	防雨罩
SK	Kryt proti dažďu	JA	雨よけ
SL	Dežna prevleka	KO	레인커버
HR	Pokrivač za kišu	BG	Дъждобран
HU	Esővédő	SR	Pokrivač za kišu
SE	Regnskydd	MS	Pelindung hujan
NO	Kalesje	HI	रेन कवर
FI	Sadesuoja	TH	ผ้าคลุมกันฝน
DA	Regnslag	SQ	Mbulesë për shiun
ET	Vihmakate	BS	Pokrivač za kišu
LV	Pretlietus pārvalks	ME	Pokrivač za kišu
LT	Uždangalas nuo lietaus	MK	Прекривка за дожд
RU	Дождевик	HY	Սննդի ամպաշտպակի ծածկ
UK	Дошовик	VI	Tấm che mưa

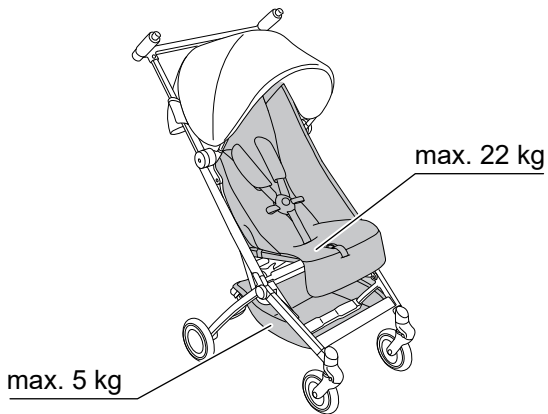

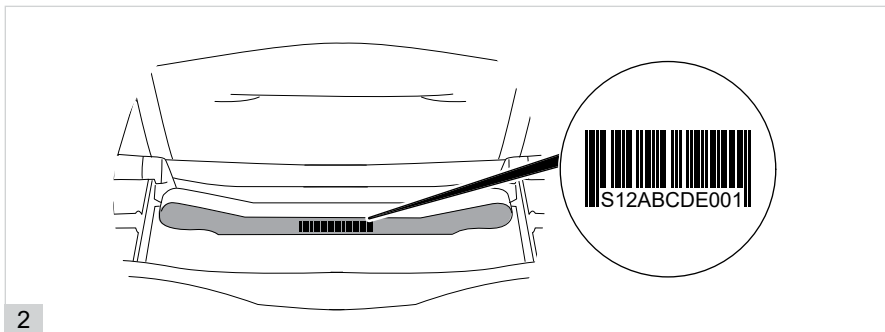
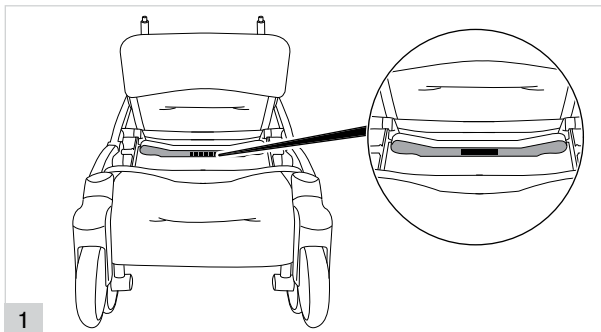



1

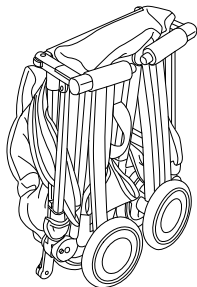

optional



optional



optional

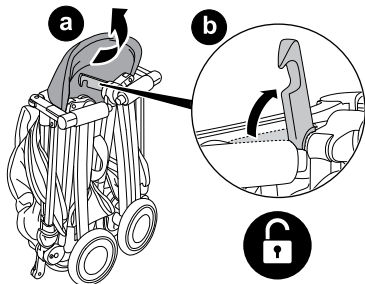

2

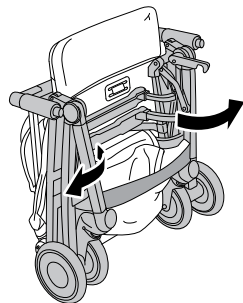

3

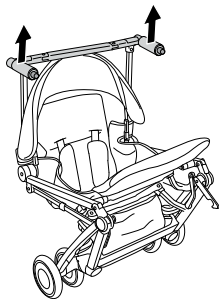

4

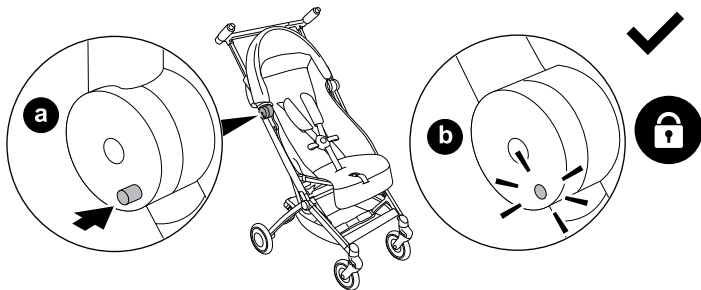

5

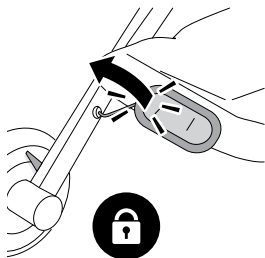

1

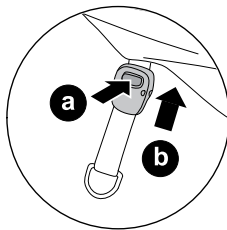
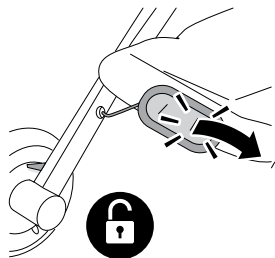

1

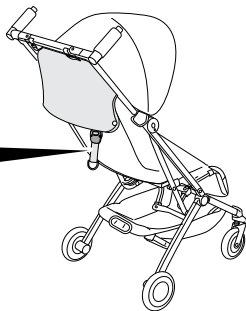

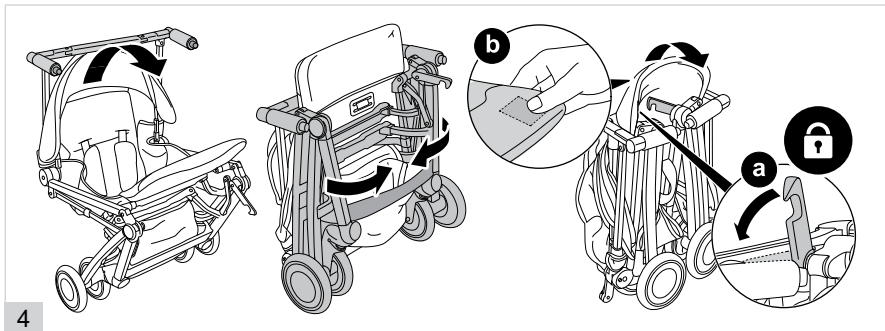
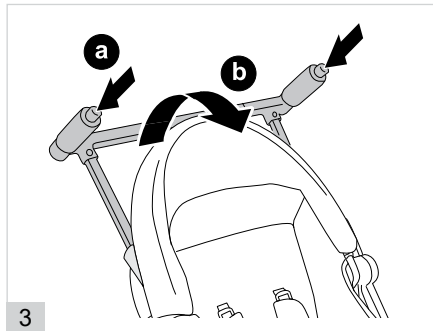

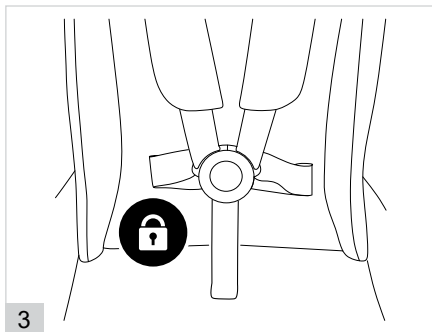
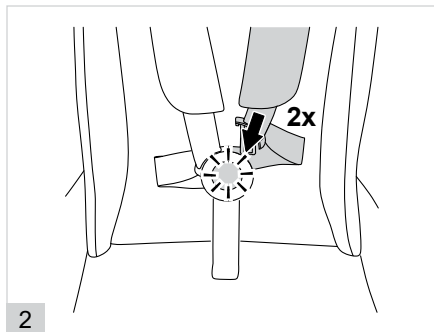
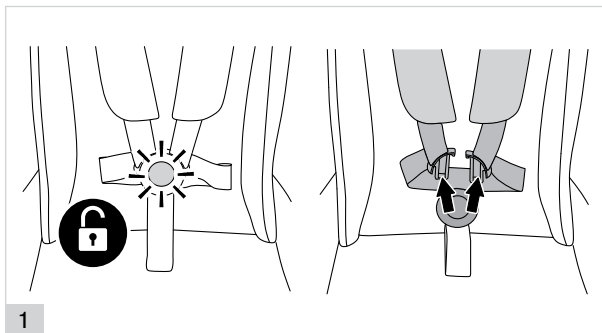

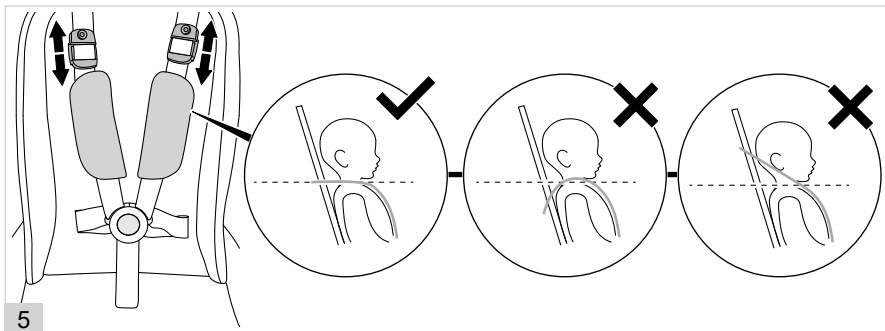
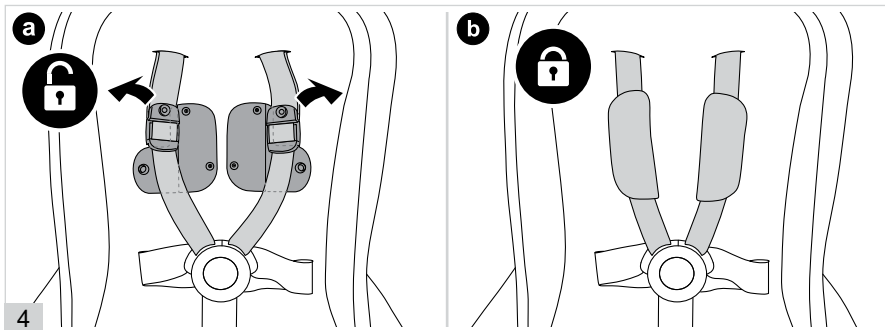

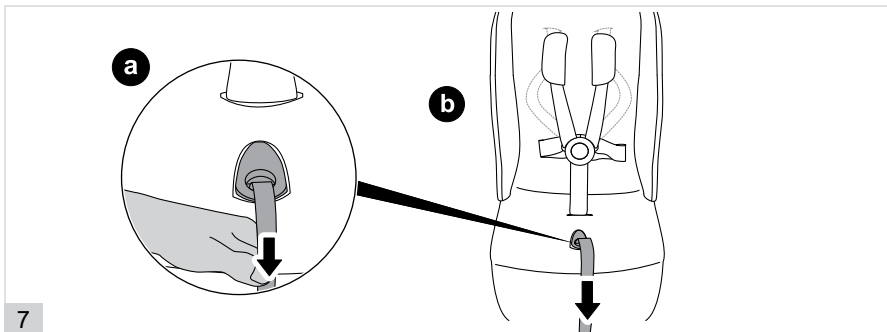
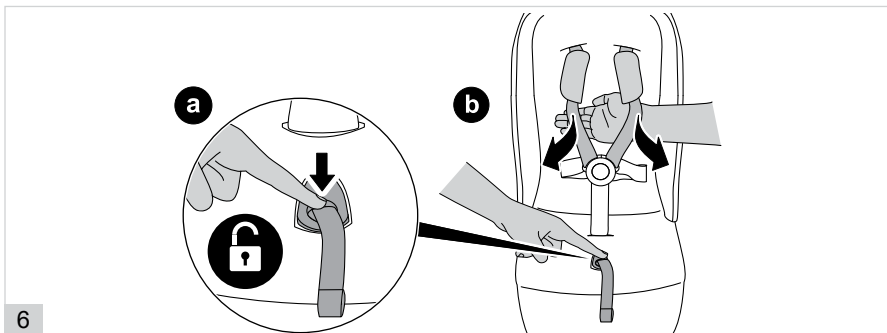

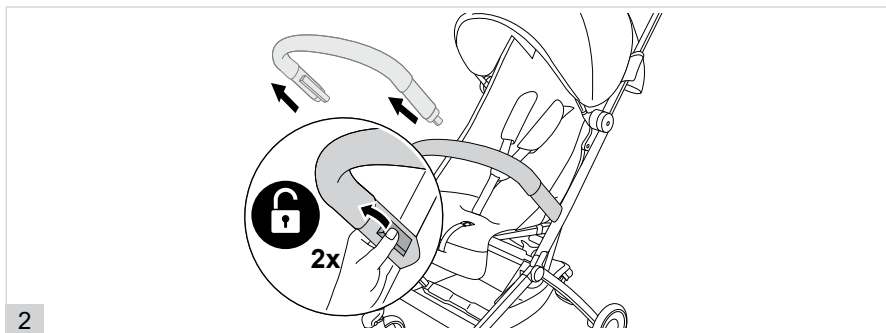
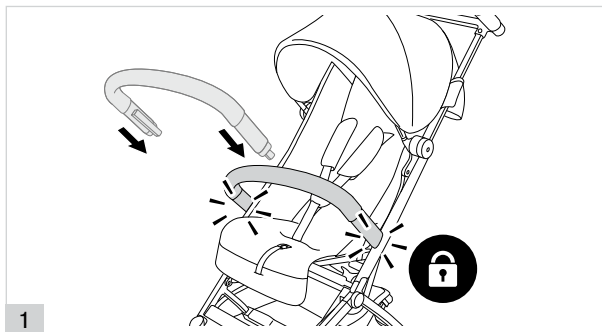

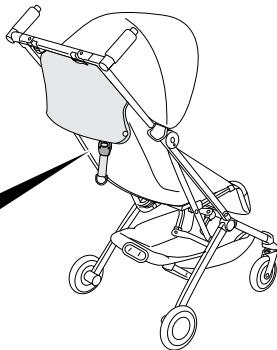
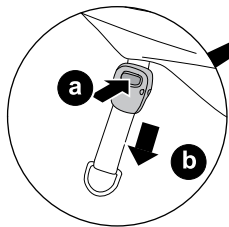
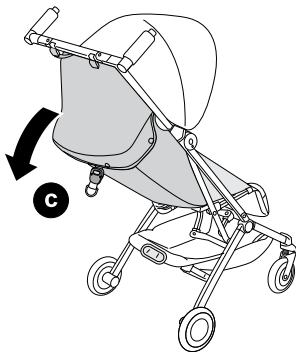

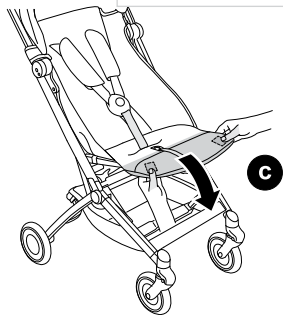
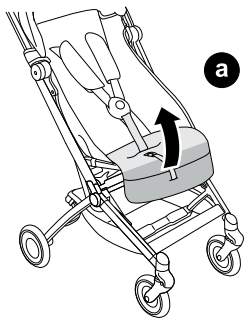

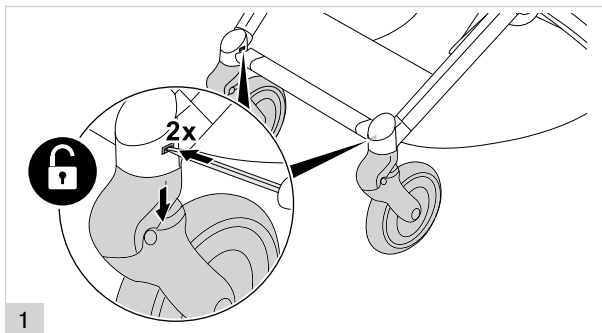

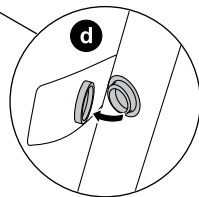
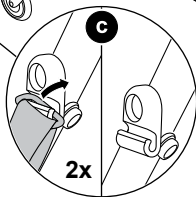
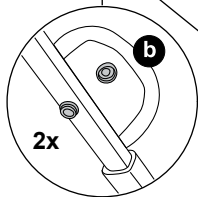
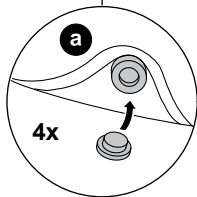
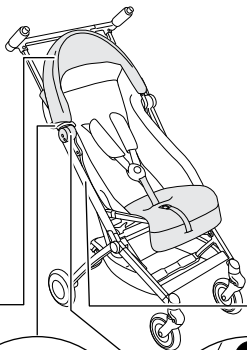

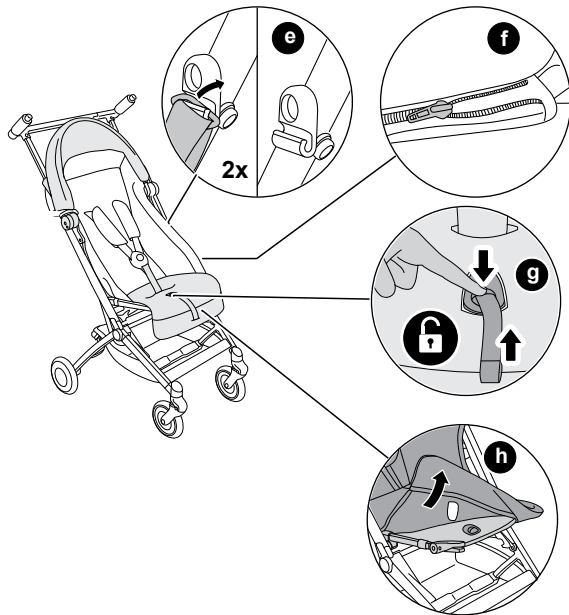

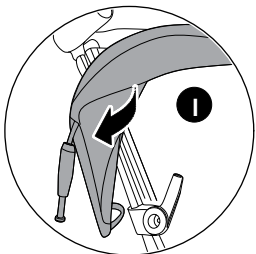
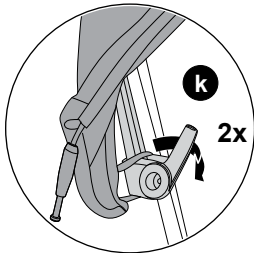
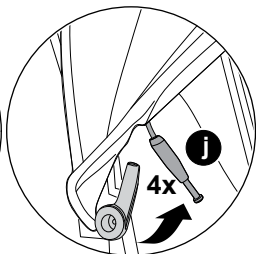
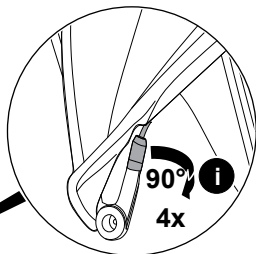
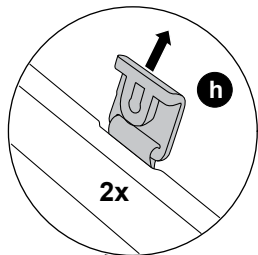

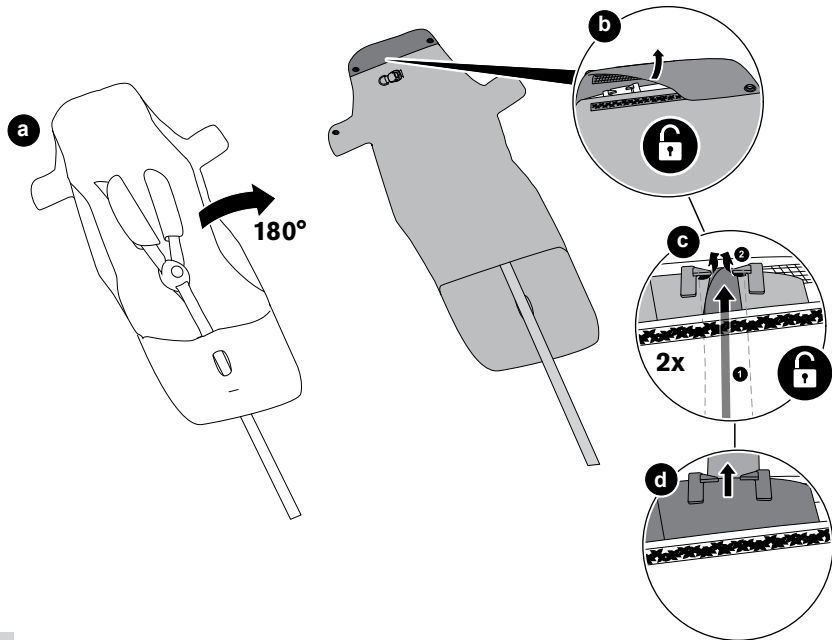

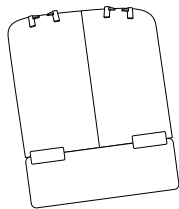
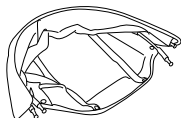
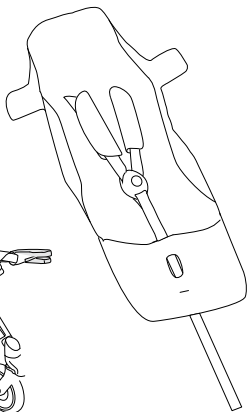



optional



a

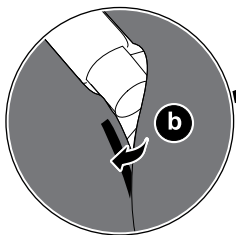

b

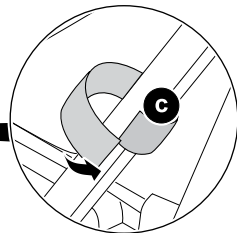
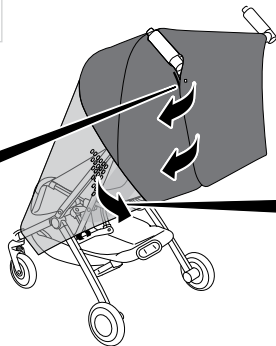

c

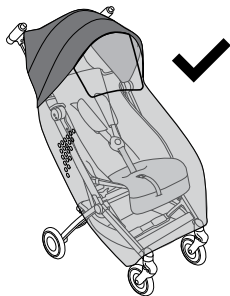
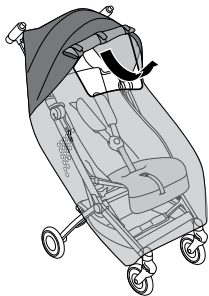

2



CYBEX GmbH
Riedingerstr. 18 | 95448 Bayreuth | Germany
+49 (0) 921-78 511-0 | info@cybex-online.com
www.cybex-online.com



FR
Cet appareil
et ses accessoires
se recyclent

REPRISE
À LA LIVRAISON

À DÉPOSER
EN MAGASIN

À DÉPOSER
EN DÉCHÈTERIE

 OU  OU 

Points de collecte sur www.quefairedemesdechets.fr