

 cybex
GOLD

ORFEO





- EN** Detailed online user guide
- DE** Ausführliche Online-Bedienungsanleitung
- ES** Manual del usuario detallado on línea
- FR** Guide utilisateur détaillé en ligne
- PT** Manual do(a) utilizador(a) online detalhado
- IT** Guida utente online dettagliata
- NL** Gedetailleerde online gebruiksaanwijzing
- PL** Szczegółowa instrukcja obsługi online
- CS** Podrobná on-line uživatelská příručka
- SK** Podrobný on-line návod na použitie
- SL** Podrobna spletna uporabniška navodila
- HR** Detaljna online uputa za upotrebu
- HU** Részletes online felhasználói útmutató
- SE** Utförlig onlinebruksanvisning
- NO** Detaljert bruksanvisning på nett
- FI** Yksityiskohtaiset online käyttöohjeet
- DA** Detaljeret online-brugsanvisning
- ET** Detailne kasutusjuhend veebis
- LV** Detalizēta tiešsaistes lietotāja rokasgrāmata
- LT** Išsami internetinė naudojimo instrukcija
- RU** Подробное онлайн-руководство пользователя
- UK** Детальна інструкція з користування
- TR** Ayrıntılı çevrimiçi kullanım kılavuzu
- EL** Απλομερές ηλεκτρονικό συγγραμμά χρήστη
- RO** Ghid detaliat de utilizare online
- IS** Nákvæm handbók á vefnum
- MT** Gwida tal-utent online dettaljat

- AR** دليل المستخدم المفصل عبر الإنترنت
- FA** راهنمای کاربر مفصل آنلاین
- YUE** 詳細線上使用香港簡
- CMN** 详细在线用户指南
- JA** 詳細なオンラインユーザーガイド
- KO** 상세 온라인 사용 설명서
- BG** Подробно онлайн ръководство на потребителя
- SR** Detaljno onlajn uputstvo za upotrebu
- MS** Panduan pengguna dalam talian yang terperinci
- HI** विस्तृत ऑनलाइन उपयोगकर्ता मार्गदर्शिका
- TH** คู่มือผู้ใช้งานออนไลน์อย่างละเอียด
- SQ** Udhëzues i detajuar online
- BS** Detaljno online uputstvo za upot rebu
- ME** Detaljno online uputstvo za upotrebu
- MK** Детално електронско упатство за корисник
- HY** Անցանց օգտագործողի մանրամասն ուղեցույց
- VI** Cẩm nang hướng dẫn sử dụng trực tuyến chi tiết



EN WARNING
DE WARNUNG
ES ADVERTENCIA
FR AVERTISSEMENT
PT AVISOS
IT ATTENZIONE
NL WAARSCHUWING
PL OSTRZEŻENIE
CS UPOZORNĚNÍ
SK UPOZORNENIE
SL OPOZORILO
HR UPOZORENJE
HU FIGYELMEZTETÉS
SE VARNING
NO ADVARSEL
FI VAROITUS
DA ADVARSEL
ET HOIATUS
LV BRĪDINĀJUMS
LT PERSPĖJIMAS
RU ВНИМАНИЕ
UK УВАГА
TR UYARI
EL ΠΡΟΕΙΔΟΠΟΙΗΣΗ
RO AVERTISMENTE
IS VIÐVÖRUN
MT TWISSUA

AR
FA
YUE 警告
CMN 警告
JA 警告
KO 경고
BG ПРЕДУПРЕЖДЕНИЕ
SR UPOZORENJE
MS AMARAN
HI चेतावनी
TH คำเตือน
SQ PARALAJMËRIM
BS UPOZORENJE
ME UPOZORENJE
MK ПРЕДУПРЕДУВАЊЕ
HY Ձգո՞րծւծո՞ր
VI CẢNH BÁO

تذہیر
اخطار



EN Tutorial video
DE Videoanleitung
ES Tutorial en video
FR Vidéo de démonstration
PT Video tutorial
IT Video tutorial
NL Instructievideo
PL Film instruktażowy
CS Vukové video
SK Vukové video
SL Video z navodili
HR Video s uputama
HU Bemutatóvideo
SE Videosjälvestudiekurs
NO Oppføringsvideo
FI Opetusvideo
DA Vejledende video
ET Õppevideo
LV Ar mācību video
LT Mokomasis vaizdo įrašas
RU Обучающее видео
UK Навчально відео
TR Öğretici video
EL Εκπαιδευτικό βίντεο
RO Video tutorial
IS Kennslumyndband
MT Tutorial fuq vidjow



شیدو تدریسی
ویدئوی آموزشی

AR
FA
YUE 教程視頻
CMN 教程視頻
JA チュートリアルビデオ
KO 튜토리얼 동영상
BG Учебно видео
SR Video sa uputstvima
MS Video tutorial
HI ऑटोरियल वीडियो
TH utorial video
SQ Video udhëzuese
BS Video sa uputstvima
ME Video sa uputstvima
MK Видеоупатство
HY Παιδαγωγικό βίντεο
VI Video hướng dẫn



EN	Maximum weights	TR	Maksimum ağırlıklar
DE	Maximalgewicht	EL	Μέγιστο βάρος
ES	Pesos máximos	RO	Greutăți maxime
FR	Poids maximum	IS	Hámarksþyngd
PT	Pesos máximos	MT	Piżijiet massimi
IT	Peso massimo	AR	الأوزان القصوى
NL	Maximumgewicht	FA	حداکثر وزن
PL	Dopuszczalna waga	YUE	最大重量
CS	Maximální hmotnosti	CMN	最大重量
SK	Maximálne hmotnosti	JA	最大重量
SL	Največje teže	KO	최대 하중
HR	Maksimalne težine	BG	Максимални тегла
HU	Maximális súlyok	SR	Maksimalne težine
SE	Max.vikter	MS	Berat maksimum
NO	Maksimumsvæktor	HI	अधिकतम भार
FI	Enimmäispainot	TH	น้ำหนักสูงสุด
DA	Maksimumvægt	SQ	Peshat maksimale
ET	Maksimaalne kaal	BS	Maksimalne težine
LV	Maksimālais svars	ME	Maksimalne težine
LT	Didžiausi svoriai	MK	Максимални тежини
RU	Максимальная масса	HY	Անվերջազույս քաշեր
UK	Максимальна вага	VI	Các mức cân nặng tối đa



EN	Product registration	TR	Ürün kaydı
DE	Produktregistrierung	EL	Καταχώριση προϊόντος
ES	Registro del producto	RO	Înregistrarea produsului
FR	Enregistrement du produit	IS	Skráning tækis
PT	Registo do produto	MT	Registrazzjoni tal-prodott
IT	Registrazione del prodotto	AR	تسجيل المنتج
NL	Productregistratie	FA	ثبت محصول
PL	Rejestracja produktu	YUE	產品註冊
CS	Registrace výrobku	CMN	产品注册
SK	Registrácia výrobku	JA	製品の登録
SL	Registracija izdelka	KO	제품 등록
HR	Registracija proizvoda	BG	Регистрация на продукта
HU	Termékgisztráció	SR	Registracija proizvoda
SE	Produktregistrering	MS	Pendaftaran produk
NO	Produktregistrering	HI	उत्पाद पंजीकरण
FI	Tuotteen rekisterointi	TH	การจดทะเบียนผลิตภัณฑ์
DA	Produktregistrering	SQ	Regjistrimi i produktit
ET	Toote registreerimine	BS	Registracija proizvoda
LV	Produkta registrācija	ME	Registracija proizvoda
LT	Gaminio registracija	MK	Регистрација на производ
RU	Регистрация продукта	HY	Ապրանքի գրանցում
UK	Росстрація продукту	VI	Đăng ký sản phẩm

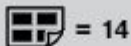

EN	Set up	TR	Kurulum
DE	Aufbau	EL	Στήσιμο
ES	Instalación	RO	Setare
FR	Montage	IS	Uppsetning
PT	Preparação	MT	Konfigurazzjoni
IT	Configurazione	AR	تنصيب
NL	Opbouw	FA	نصب کردن
PL	Montaż	YUE	設置
CS	Nastavení	CMN	设置
SK	Nastavenie	JA	セットアップ
SL	Nastavitve	KO	설정
HR	Postavljanje	BG	Настройка
HU	Felszerelés	SR	Postavljanje
SE	Inställning	MS	Pelesenan
NO	Oppsett	HI	सेट अप
FI	Asennus	TH	การติดตั้ง
DA	Opsætning	SQ	Konfigurimi
ET	Seadistamine	BS	Postavljanje
LV	Uzstādīšana	ME	Postavljanje
LT	Nuostatos	MK	Поставување
RU	Установка	HY	Հարգադրում
UK	Встановлення	VI	Cài đặt

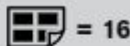

EN	Brake	TR	Fren
DE	Bremse	EL	Φρένο
ES	Freno	RO	Frână
FR	Frein	IS	Bromsa
PT	Bloqueio	MT	Brejġ
IT	Freno	AR	المكابح
NL	Rem	FA	ترمز
PL	Hamulec	YUE	剎車
CS	Brzda	CMN	剎車
SK	Brzda	JA	ブレーキ
SL	Zavora	KO	브레이크
HR	Kočnica	BG	Спирачна
HU	Fék	SR	Kočnica
SE	Broms	MS	Brek
NO	Broms	HI	ब्रेक
FI	Jarru	TH	เบรก
DA	Bremse	SQ	Frenat
ET	Pidur	BS	Kočnica
LV	Bremze	ME	Kočnica
LT	Stabdys	MK	Спирачна
RU	Тормоза	HY	Արգելակ
UK	Гальма	VI	Phanh thắng

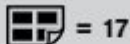

= 17

EN	Folding	TR	Katlama
DE	Faltung	EL	Ανοδιπλαση
ES	Plegado	RO	Pliere
FR	Pliant	IS	Brjota saman
PT	Fecho	MT	Tiwi
IT	Ripiegamento	AR	
NL	Vouwen	FA	
PL	Skladanie	YUE	折疊
CS	Skladání	CMN	折叠
SK	Zloženie	JA	折りたたみ
SL	Zlaganje	KO	접기
HR	Preklapanje	BG	Сгъване
HU	Összeecsukás	SR	Preklapanje
SE	Ihopfallning	MS	Lipat
NO	Sammenlogging	HI	फोल्डिंग
FI	Kokoon taittaminen	TH	พับกระดาษ
DA	Sammenklapning	SQ	Palosja
ET	Kokkuvoltimine	BS	Preklapanje
LV	Salocīšana	ME	Preklapanje
LT	Lankstymas	MK	Склопување
RU	Складывание	HY	Ծալումը
UK	Складання	VI	Gấp lại

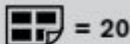
قائمة للطى
تاكيد

= 20

EN	Harness	TR	Emniyet kemeri
DE	Gurtsystem	EL	Συγκράτηση
ES	Arnés	RO	Centură
FR	Harnais	IS	Boisli
PT	Arnês	MT	Cinga tas-sigurtà
IT	Imbracatura	AR	حزام اشد
NL	Harnas	FA	سیستم مهار
PL	Szokli	YUE	安全帶
CS	Popruh	CMN	安全带
SK	Popruh	JA	安全ベルト
SL	Varnostni pas	KO	안전띠
HR	Sustav vezivanja	BG	Сбруя
HU	Biztonsági öv	SR	Sistem vezivanja
SE	Sele	MS	Abah-abah
NO	Boltesystem	HI	बन्धक
FI	Vyöjärjestelmä	TH	ระบบสายรัด
DA	Selesystem	SQ	Pajimet
ET	Turvarihmad	BS	Sistem vezivanja
LV	Drošības josta	ME	Sistem vezivanja
LT	Diržai	MK	Сигурносен каиш
RU	Ремни безопасности	HY	Ամրագրուի
UK	Ремінь	VI	Dây an toàn

 = 23

EN Backrest
DE Rückenlehne
ES Respaldo
PT Encosto
FR Dossier
IT Schienale
NL Rugleuning
PL Oparcie
CS Opěradlo
SK Operadlo
SL Naslonjalo
HR Naslon
HU Háttámla
SE Ryggstöd
NO Ryggstøle
FI Selkänöja
DA Ryglæn
ET Seljatugi
LV Atzvoltnē
LT Nugaros atlošas
RU Спинка
UK Спинка
TR Arkalık

EL Πλάτη
RO Spătar
IS Bak
MT Serh id-dahar
AR مسند الظهر
FA پشتی
YUE 靠背
CMN 靠背
JA 背もたれ
KO 등받이
BG Облегалка
SR Naslon
MS Peryandar belakang
HI पीठपट्टा
TH ไม้พนัก
SQ Mbeshtetësja e shpinës
BS Naslon
ME Naslon
MK Наслон за грб
HY Թիղթալ
VI Phần tựa lưng

 = 24

EN Legrest
DE Beinstütze
ES Reposapiés
FR Repose-pieds
PT Apoio de pernas
IT Poggiagambe
NL Beensteun
PL Podnózek
CS Opěrka nohou
SK Opierka nôh
SL Naslon za nogo
HR Naslon za nogo
HU Lábtartó
SE Benstöd
NO Benstøtte
FI Jalkatuki
DA Benstøtte
ET Jalatugi
LV Kāju balsts
LT Kojų atrama
RU Подставка для ног
UK Опора для ніг
TR Bacak desteği

EL Στήριγμα ποδιών
RO Suport picior
IS Fótahvlla
MT Serh is-saqajn
AR مسند الساق
FA چاهای
YUE 腿托
CMN 腿托
JA 足のせ
KO 다리받이
BG Подложка за крака
SR Naslon za nogo
MS Tempat letak kaki
HI पैरपट्टा
TH ไม้เท้า
SQ Mbeshtetësja e këmbëve
BS Naslon za nogo
ME Naslon za nogo
MK Наслон за нозе
HY Ուղղորդի հետմասն կտն
VI Phần tựa chân

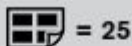

= 25

EN	Sun canopy	EL	Κουκούλα για τον ήλιο
DE	Sonnenwerdeck	RO	Copertină
ES	Capota para el sol	IS	Solartjald
FR	Pare-soleil	MT	Kopertura mix-xomx
PT	Capota solar	AR	مظلة الشمس
IT	Parasole	FA	سایه بان
NL	Zonnekap	YUE	遮陽篷
PL	Oslona przeciwsłoneczna	CMN	遮阳篷
CS	Stříška proti slunci	JA	日よけカ/ア一
SK	Strieška proti slnku	KO	선개노피
SL	Senčnik za zaščito pred soncem	BG	Тента
HR	Tenda za sunce	SR	Tenda za sunce
HU	Kupola	MS	Kanopi matahari
SE	Solsufflett	HI	सूर्य छतरी
NO	Solskjerm	TH	ม้านั่งร่มเงา
FI	Aurinkokatos	SQ	Strea për diellin
DA	Solkaleche	BS	Tenda za sunce
ET	Päikesevari	ME	Tenda za sunce
LV	Saulės aizsargs	MK	Стреа за сонце
LT	Stogelis nuo saulės	HY	Արևապաշտպան ծածկ
RU	Солнцезащитный козырек	VI	Mái che nắng
UK	Тент від сонця		
TR	Güneş başlığı		

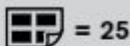

= 25

EN	Removing the wheels	EL	Αφαίρεση των τροχών
DE	Entfernen der Räder	RO	Îndepărtarea roților
ES	Quitar las ruedas	IS	Fjarlægja hjól
FR	Retrait des roues	MT	Tnehhija tar-roti
PT	Remover as rodas	AR	فك العجلات
IT	Rimozione delle ruote	FA	باز کردن چرخ ها
NL	De wielen verwijderen	YUE	拆卸車輪
PL	Zdejmowanie kółek	CMN	拆卸车轮
CS	Odstranění koloček	JA	車輪の取り外し
SK	Odstránenie koliesok	KO	휠 제거
SL	Odstranjevanje koles	BG	Демонтиране на колелата
HR	Uklanjanje kotača	SR	Uklanjanje točkova
HU	Kerekeltávolítás	MS	Menanggalkan roda
SE	Ta bort hjulen	HI	पहियों को हटाना
NO	Fjerne hjulene	TH	การถอดล้อ
FI	Puhtien poisto	SQ	Heqja e rrotave
DA	Fjernelse af hjulene	BS	Uklanjanje točkova
ET	Rataste eemaldamine	ME	Uklanjanje točkova
LV	Riteņu atvienošana	MK	Отстранување на тркалата
LT	Ratų nuėmimas	HY	Արււյւծըղ հաււծըղ
RU	Снятие колес	VI	Tháo bánh xe
UK	Зняття коліс		
TR	Tekerlekleri çıkarma		



 = 27

EN Removing the fabric	EL Αφαίρεση του υφάσματος
DE Entfernen des Bezuges	RO Îndepãrtarea țesãturii
ES Quitar la tela	IS Fjarlægginga efni
FR Retrait du tissu	MT Tnehhija tad-drapp
PT Remover o tecido	AR إزالة القماش
IT Rimozione del tessuto	FA برداشتن پارچه
NL De stof verwijderen	YUE 拆掉㗎布
PL Zdejmowanie pokrycia	CMN 拆掉㗎布
CS Odstrãní látky	JA カバーの取り外し
SK Odstrãnenie látky	KO 커버를 제거
SL Odstrãnjevanje blaga	BG Демонтирано на плата
HR Uklanjanje tkanine	SR Uklanjanje tkanine
HU Huzat eltávolítása	MS Menanggalkan fabrik
SE Ta bort tyget	HI कपड़ा हटाना
NO Fjerne stoffet	TH ๓๓๓๓๓๓
FI Kankaan poisto	SQ Heqja e sorës
DA Fjernelse af stoffet	BS Uklanjanje tkanine
ET Kanga eemaldamine	ME Uklanjanje tkanine
LV Pãrkãjuma atvienošana	MK Отстранување на навлаката
LT Audinio nuėmimas	HY Գործվածքը հանելը
RU Снятие ткани	VI Tháo phãn vải bọc
UK Зняття матерії	
TR Kılıf çıkarma	

 = 35

EN Rain cover	EL Καλύπτρα βροχής
DE Regenverdeck	RO Prelatã de ploaie
ES Funda para la lluvia	IS Regn yfirbroiðisla
FR Housse de pluie	MT Ghata mix-xita
PT Capa de chuva	AR غطاء المطر
IT Parapioggia	FA روکش باران
NL Regenhoes	YUE 防雨罩
PL Osłona od deszczu	CMN 防雨罩
CS Ploštãnka	JA 雨ふけ
SK Kryt proti daždu	KO 레인커버
SL Dežna prevleka	BG Дъждобран
HR Pokrivač za kišu	SR Pokrivač za kišu
HU Esővédő	MS Pelindung hujan
SE Regnskydd	HI रैन कवर
NO Kalosje	TH ๓๓๓๓๓๓๓๓
FI Sadesuoja	SQ Mbulesë për shiun
DA Regnslag	BS Pokrivač za kišu
ET Vihmakato	ME Pokrivač za kišu
LV Pretlietus pãrvalks	MK Прокривана за дожд
LT Uždangalas nuo lietaus	HY Անձրևապաշտպան ծածկ
RU Дождевик	VI Tãm che mưa
UK Дощовник	
TR Yağmurluk	

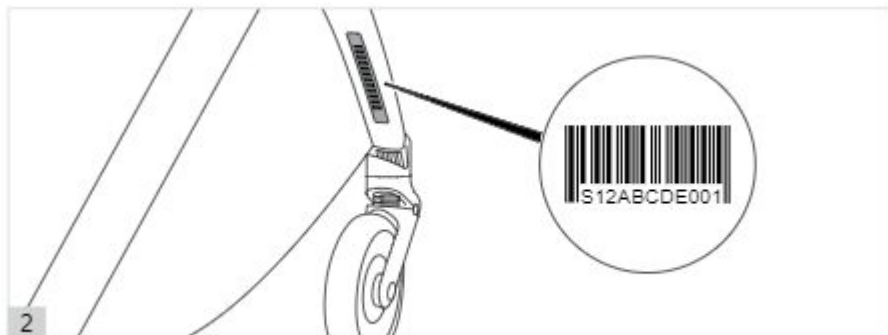
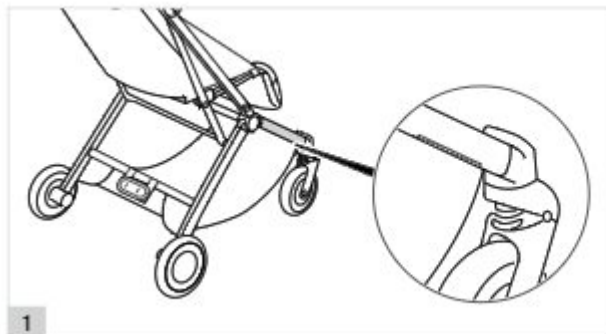





1

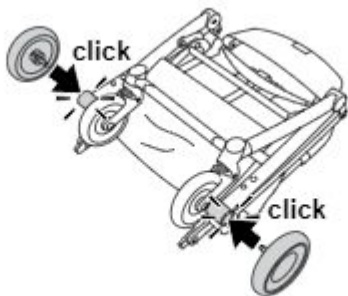
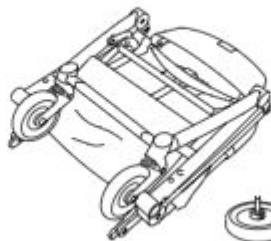

14

2

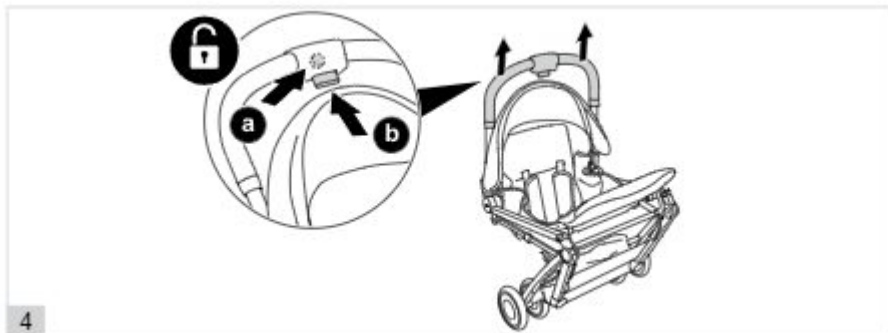
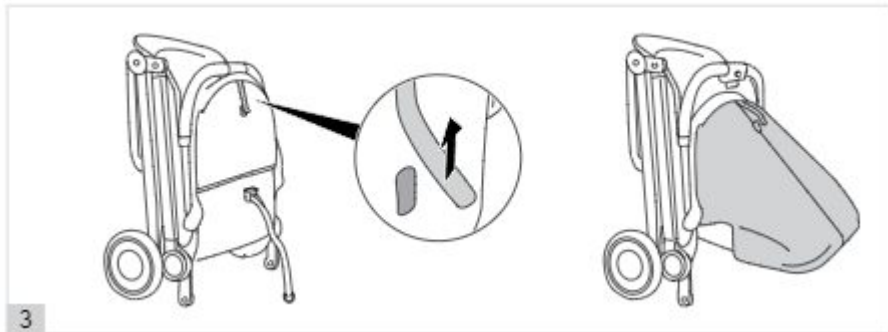

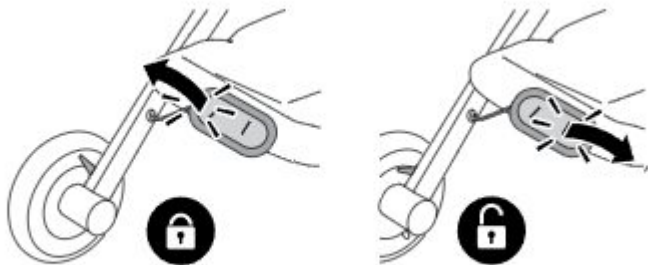
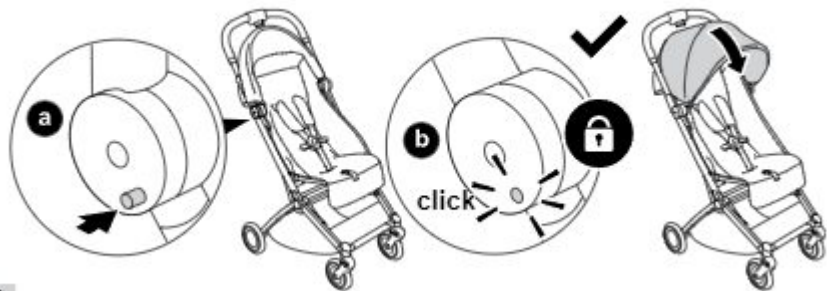

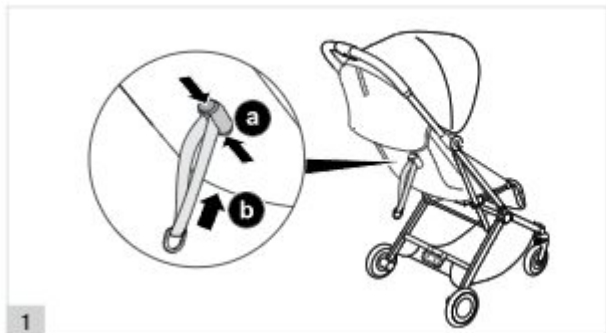

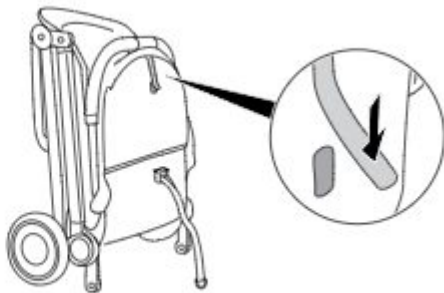



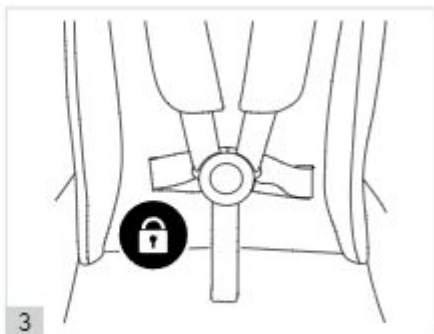
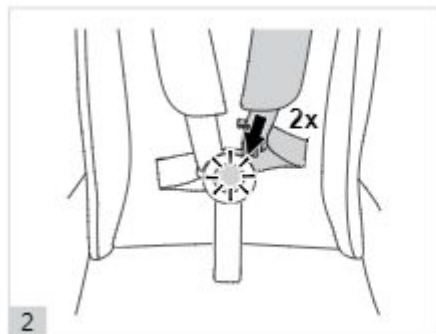
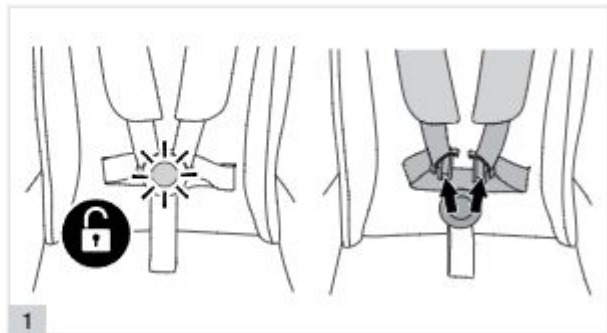

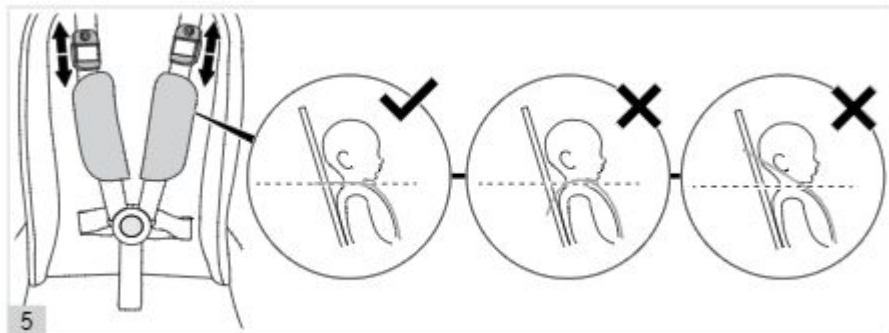
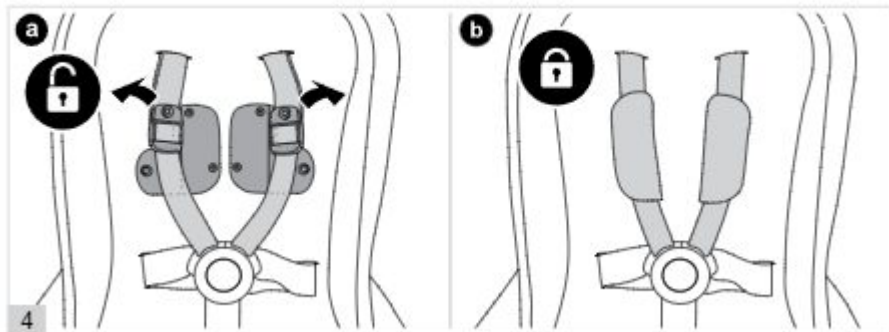

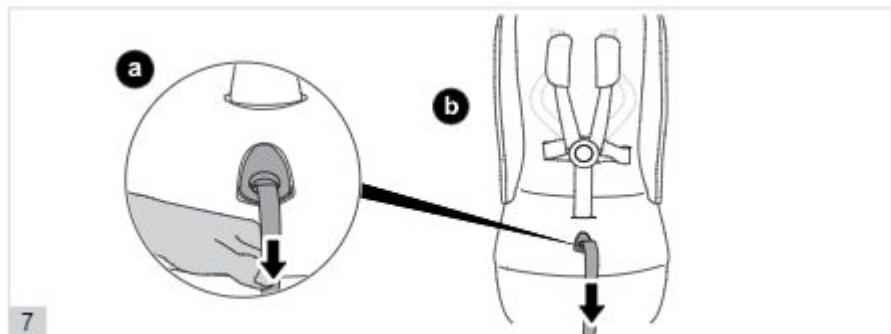
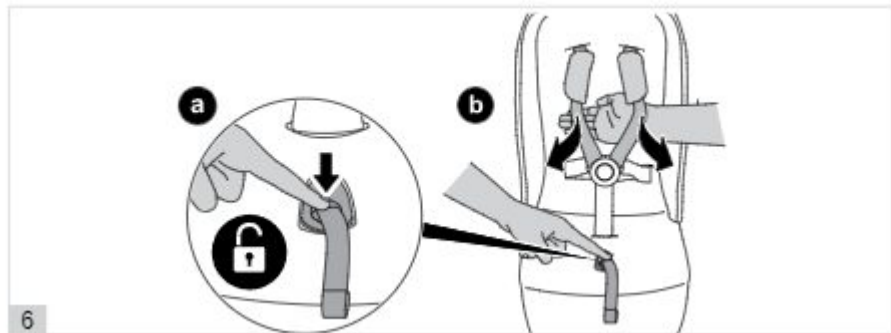

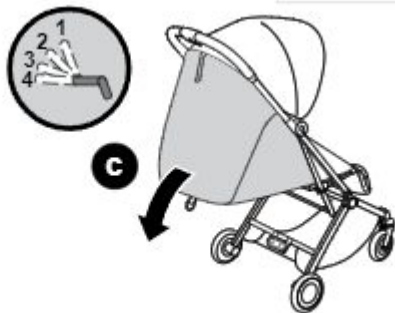
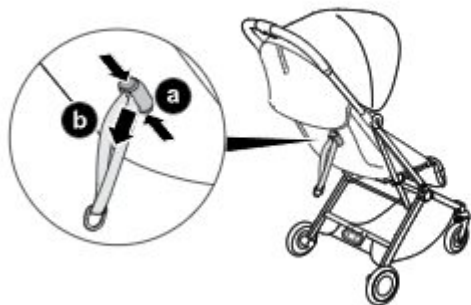



a



b



c



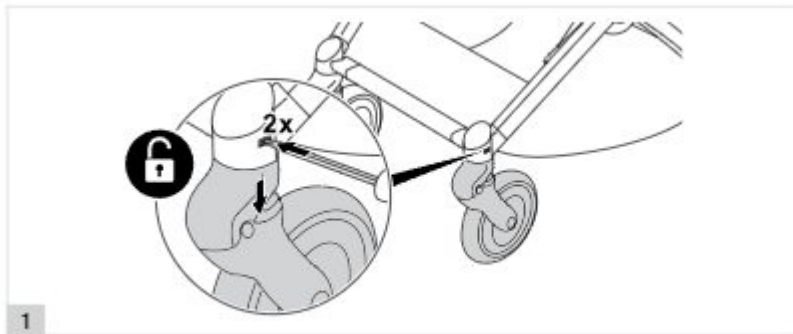
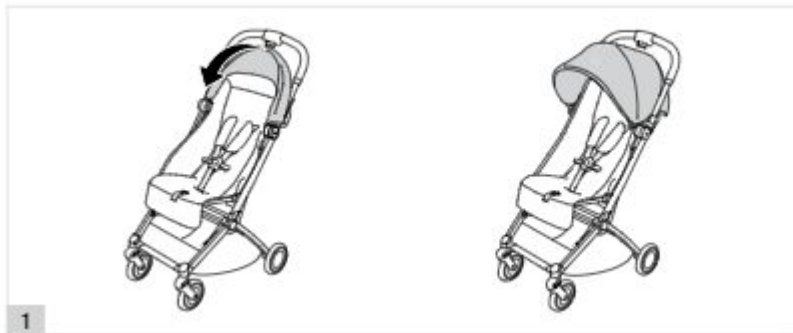

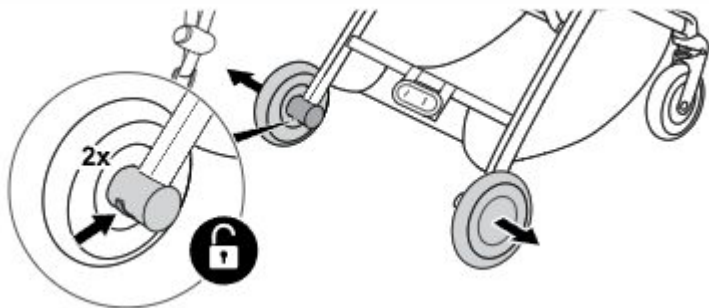

2

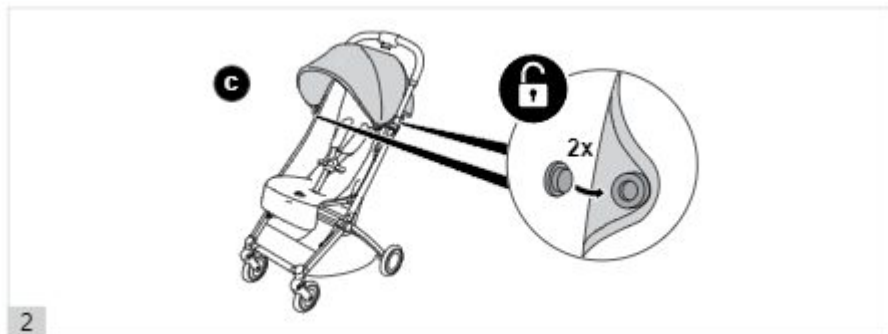
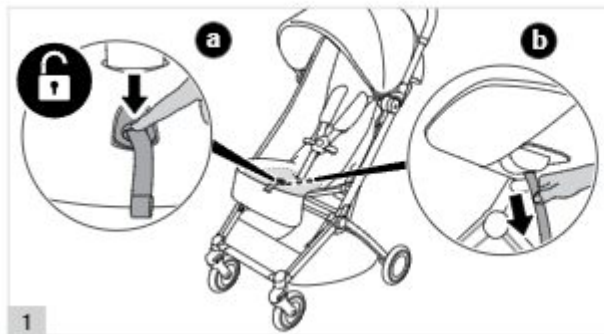

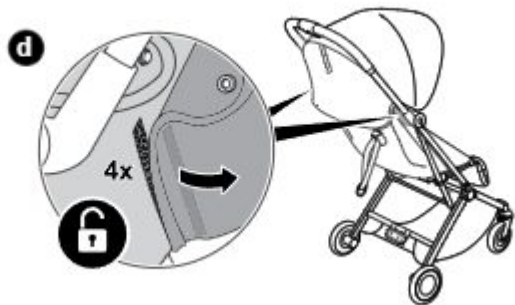

3

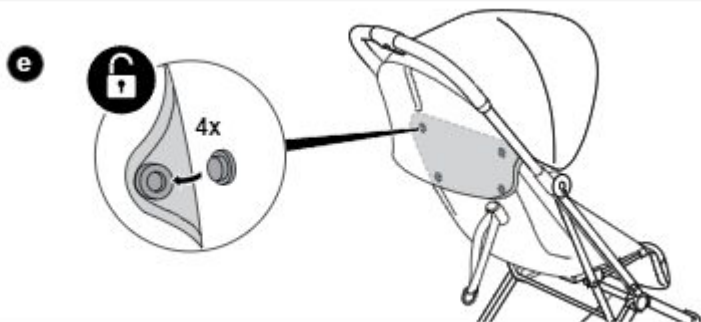

4

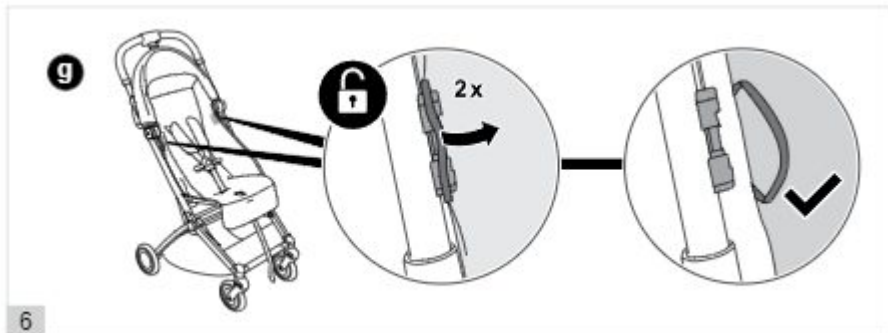
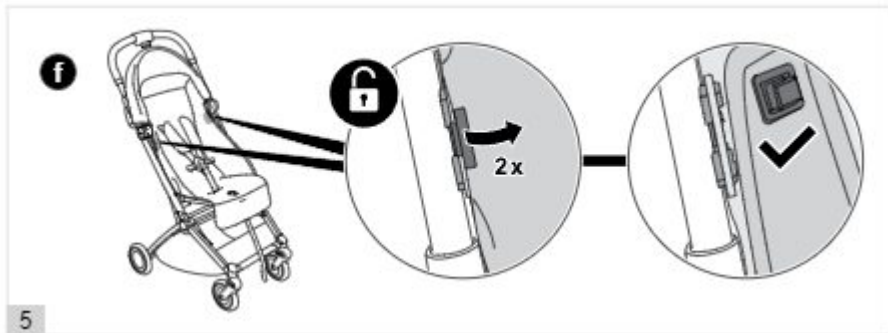

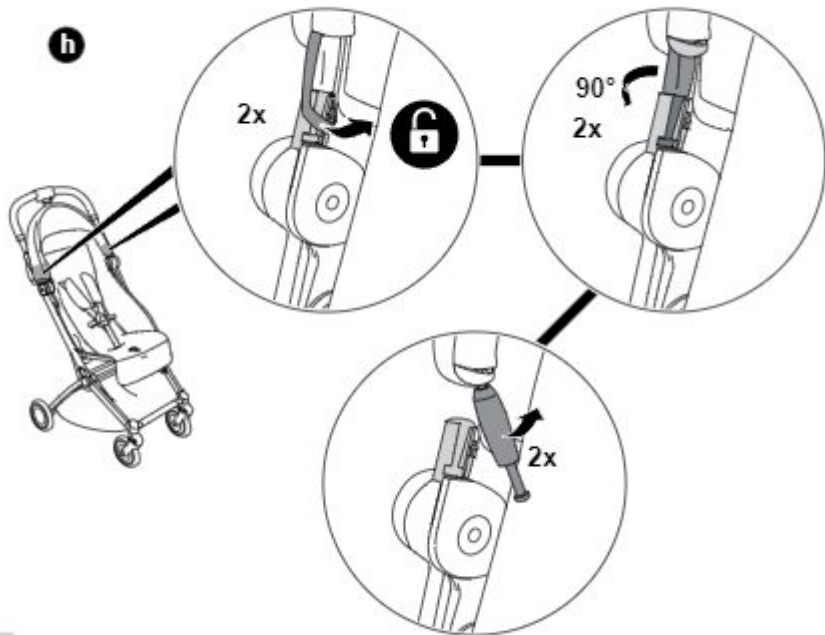

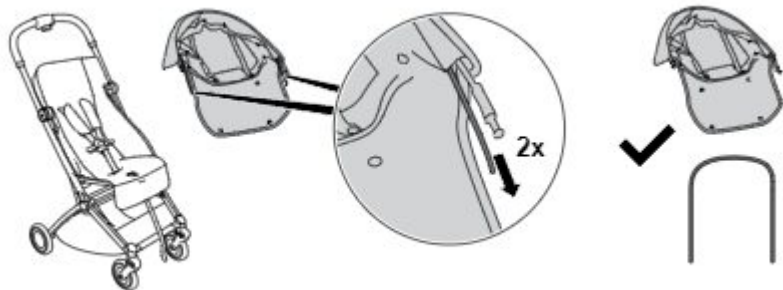
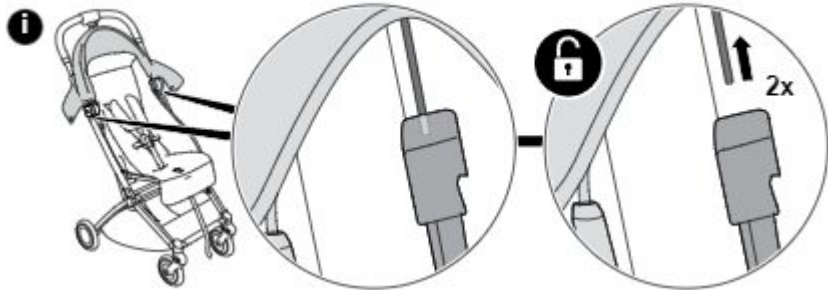

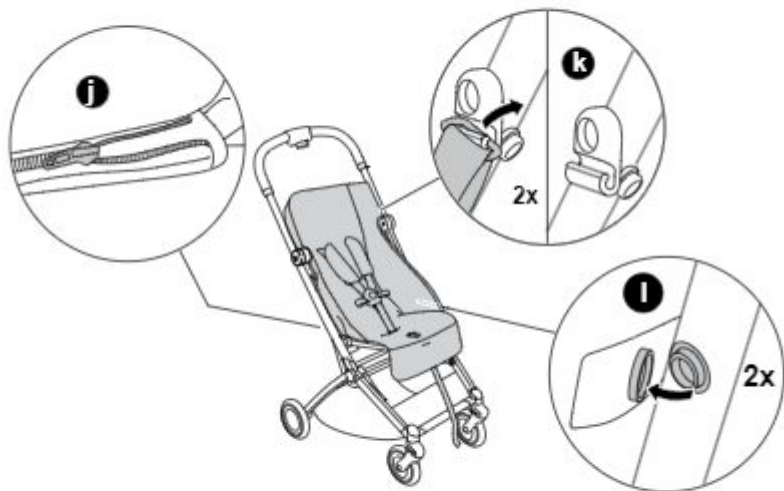

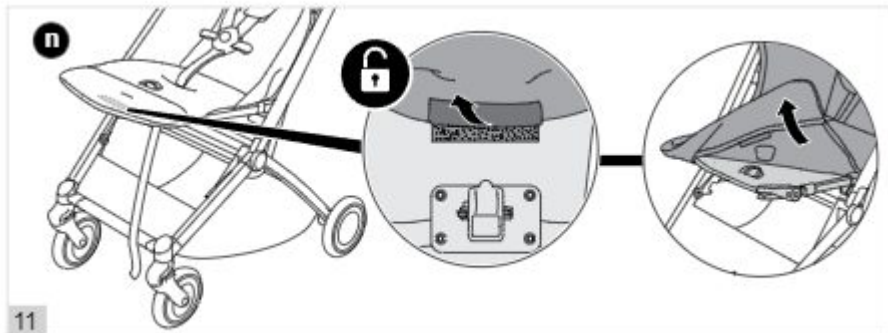
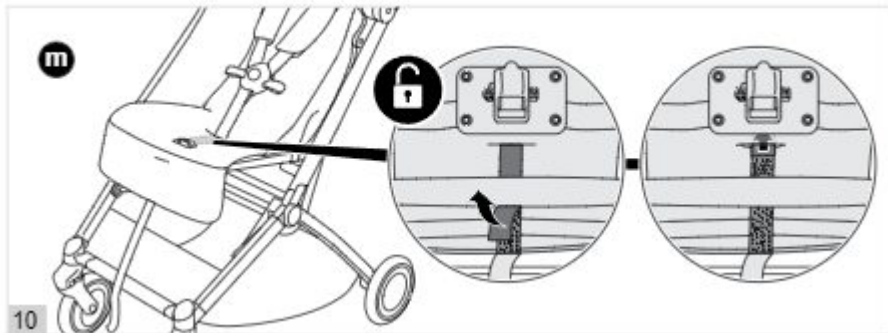

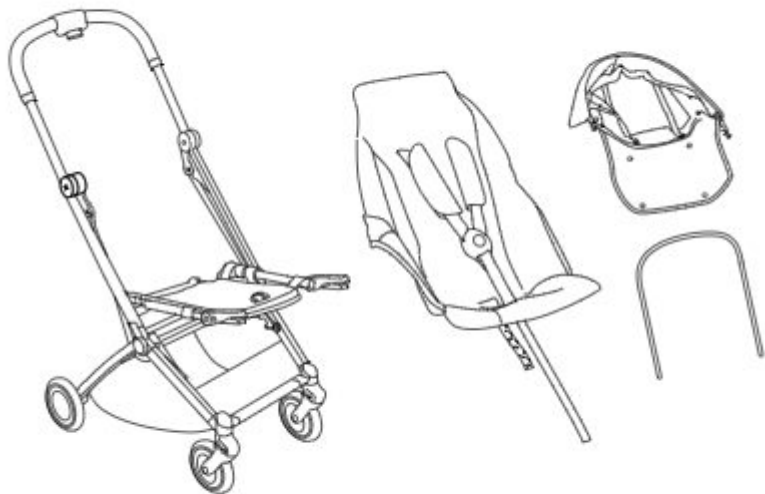



1

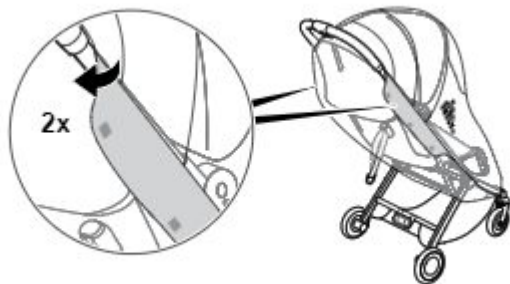

2

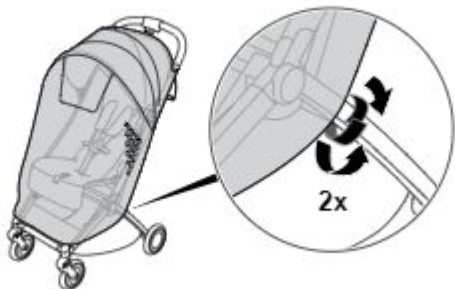

3



4



5



CYBEX GmbH
Riedingerstr. 18 | 95448 Bayreuth | Germany
+49 (0) 921-78 511-0 | info@cybex-online.com
www.cybex-online.com

 cybex



FR
Cet appareil
et ses accessoires
se recyclent

REPRISE
À LA LIVRAISON

À DÉPOSER
EN MAGASIN

À DÉPOSER
EN DÉCHÈTRE

 **OU**  **OU** 

Points de collecte sur www.quefairedesdechets.fr