

Chelino

PLATINUM

ECE R129/03

Forward Facing: Child height 76cm-150cm

Rearward Facing: Child height 40cm-105cm / Child weight \leq 18kg



FALCON II-360°I SIZE

CHELINOBABY GROUP OF COMPANIES.
NO. 12 KIMBERLITE ROAD, THETA EXT 5, BOOYSENS RESERVE, JHB, 2091.SA.
Tel: +2711 8352520

www.chelinobaby.co.za



NOTICE

Notice regarding i-Size category Enhanced Child Restraint Systems (40-105cm)

This is an i-Size Enhanced Child Restraint System.

It is approved according to UN Regulation No. 129, for use in, i-Size compatible vehicle seating positions as indicated by vehicle manufacturers in the vehicle users' manual.

If in doubt, consult either the Enhanced Child Restraint System manufacturer or the retailer.

Notice regarding i-Size booster seat category Enhanced Child Restraint Systems (100-150cm)

This is a i-Size booster seat Enhanced Child Restraint System. It is approved according to UN Regulation No. 129, for use primarily in " i-Size seating positions" as indicated by vehicle manufacturers in the vehicle user's manual.

If in doubt, consult either the Enhanced Child Restraint System manufacturer or the retailer.

NOT TO USE REARWARD FACING ECRS IN SEATING POSITIONS WHERE THERE IS AN ACTIVE FRONTAL AIRBAG INSTALLED.

"IMPORTANT - DO NOT USE FORWARD FACING BEFORE THE CHILD'S AGE EXCEEDS 15 months (Refer to instructions)".

To use this enhanced child seat approved to the ECE R129/03 regulation, your child must meet the following requirements.

Forward Facing: Child height 76cm-150cm

Rearward Facing: Child height 40cm-105cm / Child weight \leq 18kg;

Feature

This enhanced child seat can be adjusted 360° rotation.

According to UN Regulation No/129/03, this enhanced child seat is a Universal ISOFIX Child Restraint and should be fitted using the ISOFIX connections. To use this enhanced child seat approved to the ECE R129/03 Regulation, your child must meet the following requirements.

WARNING

- In order to properly protect your child, please take the time to read the instruction manual and install the enhanced child seat and use it exactly as described in the instruction manual at all times.
- This instruction manual must be retained in hand in the instruction manual storage compartment at tie back of the seat body for its life period at all times.
- To use this child seat with the ISOFIX connections according to the ECE R129/03 Regulation, your child must meet the following requirements.

Forward Facing: Child height 76cm-150cm

Rearward Facing: Child height 40cm-105cm/ Child weight ≤ 18kg;

“IMPORTANT - DO NOT USE FORWARD FACING BEFORE THE CHILD’S AGE EXCEEDS 15 months (Refer to instructions)”.

Keep your child rearward facing as long as possible as rearward facing is the safest position.

WARNING : DO NOT use rearward facing child seat in seating positions where an active frontal airbag installed . Death or serious injury can occur.

- Do not use this enhanced child seat in the home. It has not been designed for home use and should only be used in your car.
- Do not leave your child unattended in the enhanced child seat at any time.
- The rigid items and plastic parts of an ECRS must be so located

and use of the vehicle, to become trapped by a movable seat or in a door of the vehicle.

- Any straps holding the restraint to the vehicle should be tight, that any support-leg should be in contact with the vehicle floor, that any straps or impact shields restraining the child should be adjusted to the child's body, and that straps should not be twisted.
- Ensuring that any lap strap is worn low down, and that any impact shield installed properly, so that the pelvis is firmly engaged, shall be stressed
- The device should be replaced when it has been subject to violent stresses in an accident
- It is dangerous that making any alterations or additions to the device without the approval of the Type Approval Authority, and not following closely the installation instructions provided by the child restraint manufacturer
- The chair should be kept away from sunlight, otherwise it may be too hot for the child's skin.
- Any luggage or other objects liable to cause injuries in the event of a collision shall be properly secured.
- The ECRS must not be used without the cover. the ECRS cover should not be replaced with any other than the one recommended by the manufacturer, because the cover constitutes an integral part of the restraint performance.
- Not to use any load bearing contact points other than those described in the instructions and marked in the ECRS.
- Please referred to the vehicle manufacturer's handbook before installing this i-size ECRS.



Installation position



- A** Car Safety Belt: Diagonal Belt
- B** Car Safety Belt: Lap Belt
- C** ISOFIX Attachments

1 When using as i-Size

This ECRS system is suitable for vehicles equipped with the ECE R14 requirements. And only after installed ISOFIX, then can use on it.

2 When using as i-Size booster seat

This ECRS system is suitable for seat belt that has passed the ECE R16 requirement and is not suitable for models only equipped with 2-point seat belts. And only after installed ISOFIX, then can use on it.



The suitable location for installation on the car is shown on the left:



⊘ Not allowed to install child car seat.

✓ Safe to install child car seat.

A Only with 3-point seat belt and ISOFIX attachments can install in this place.

B Can not install with active airbag in the front seat.



Parts List

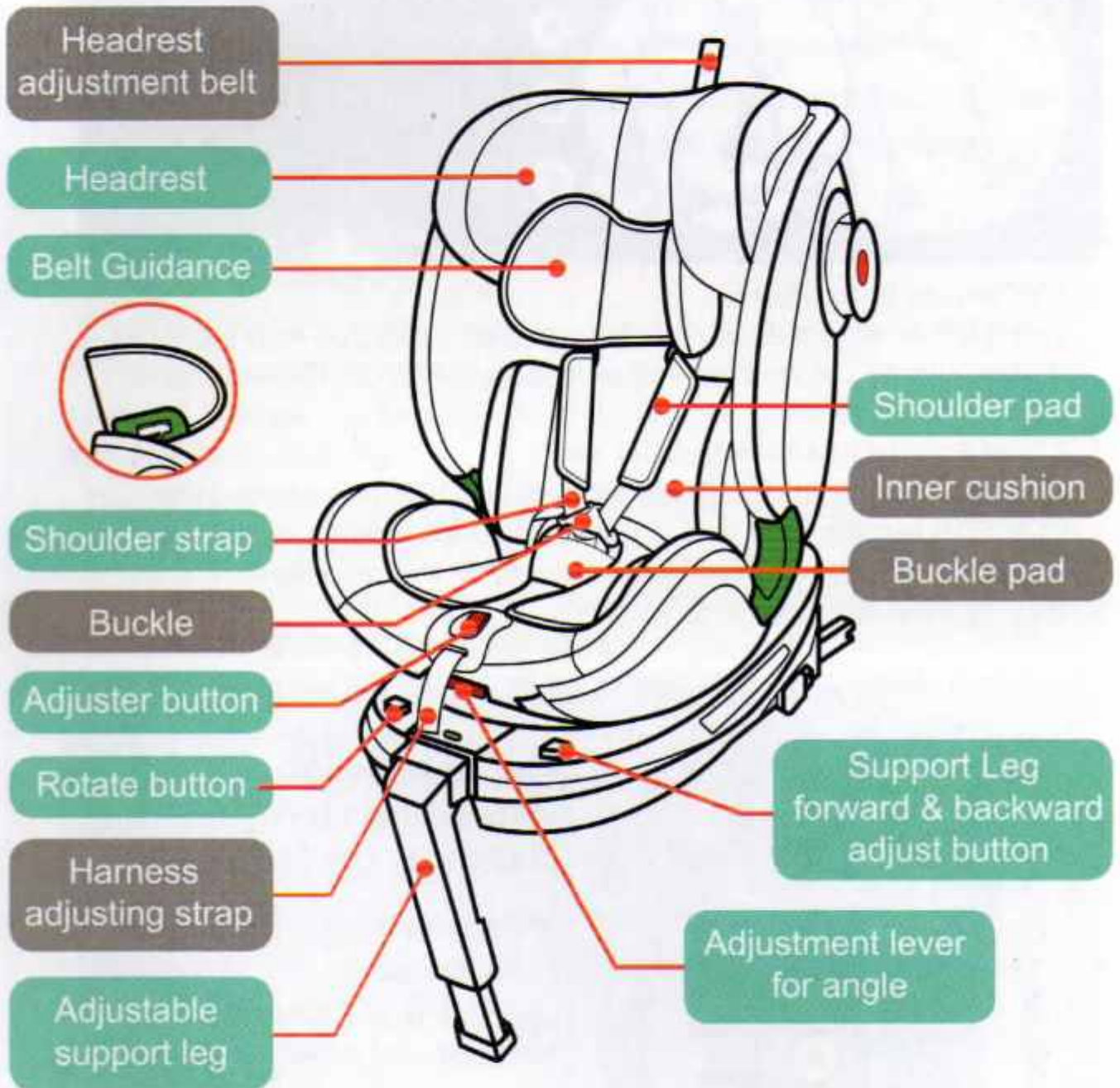

Noice: Inner cushion is suitable for child height of 40-75cm.

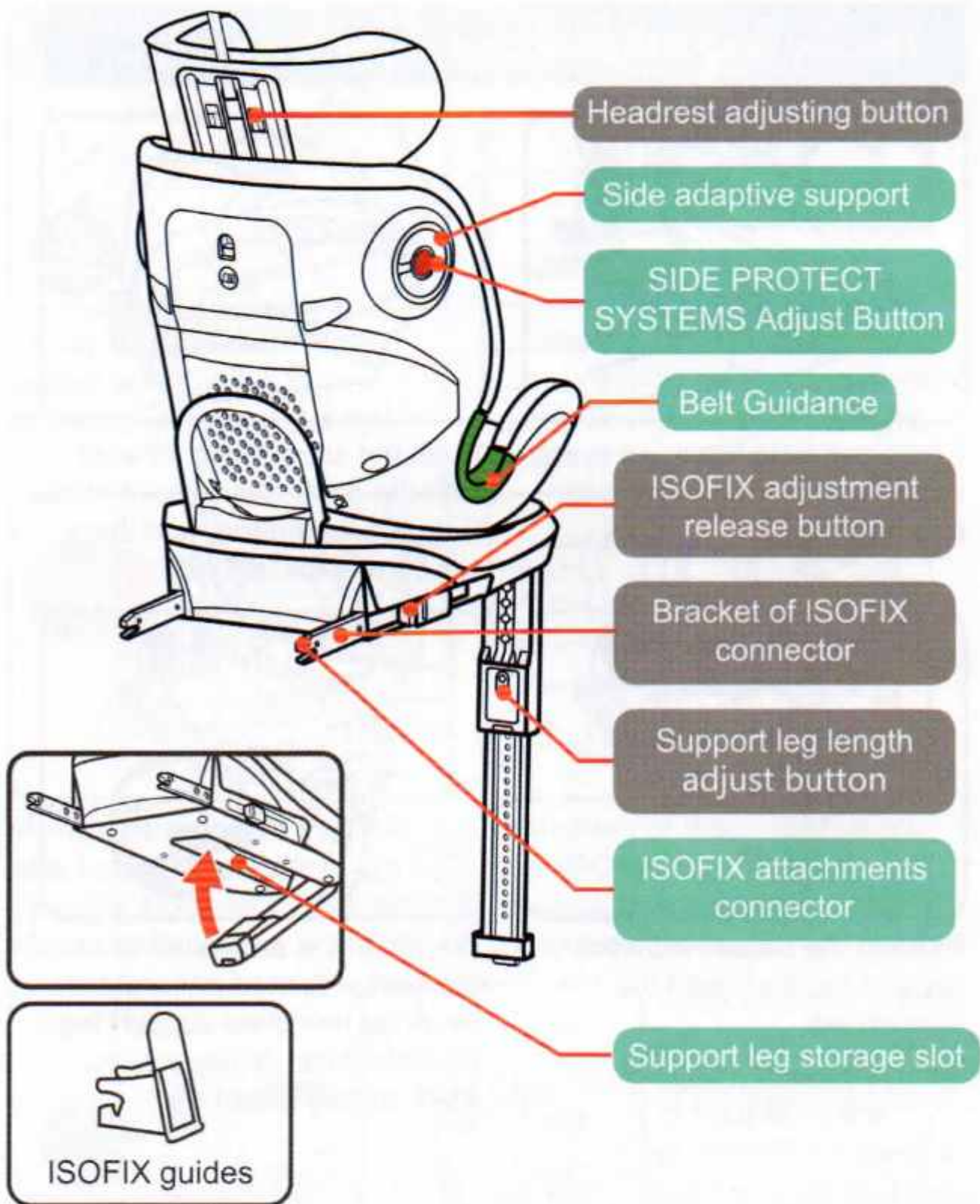

Take care of all spare part, any lost make sure to contact with manufacturer, The parts lack of damaged baby car seats are not allowed to use.

How to install ISOFIX and support leg

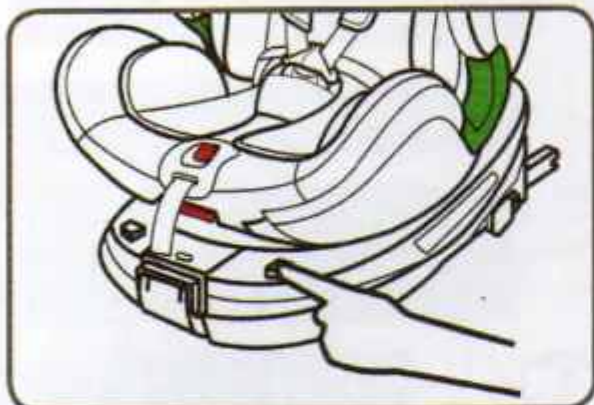

Press and hold the adjustment button of the support leg with one hand.

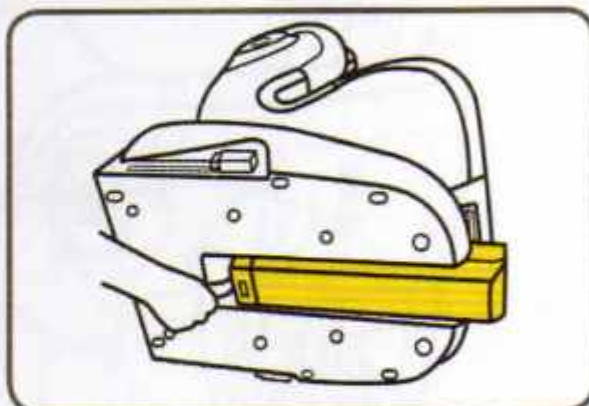

Push the support leg forward with the other hand until it stops. Release the button, and there will be a "click" sound.

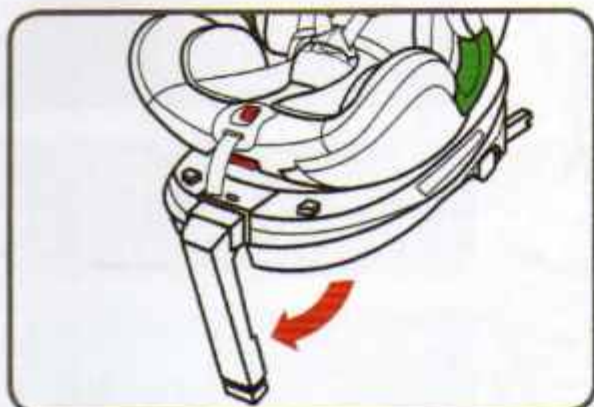

Expand the bottom outward support leg and open the support leg.

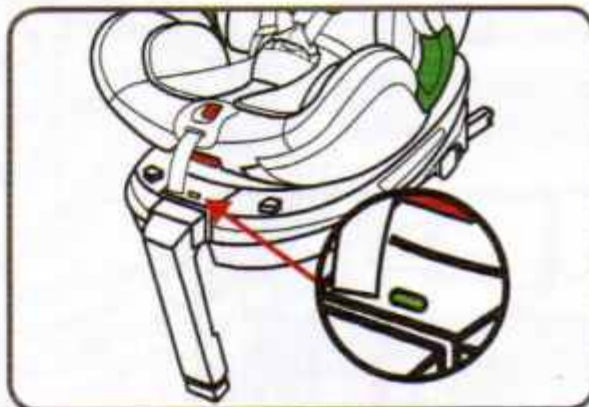

Warning: It is prohibited to use the seat with the front and rear length of unlocked support leg for installation. When locked, it will display green.



Fit the ISOFIX attachments guides with the ISOFIX attachments anchor points.

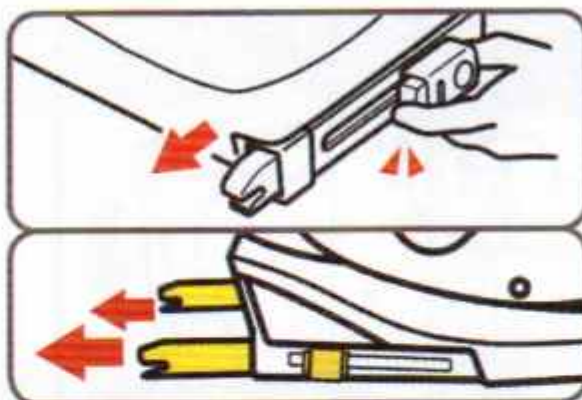

Extend the ISOFIX attachments connectors by depressing on the release button. Adjust the right length of the ISOFIX connector.



Make sure that both ISOFIX attachments connectors are securely attached to their ISOFIX attachments anchor points.

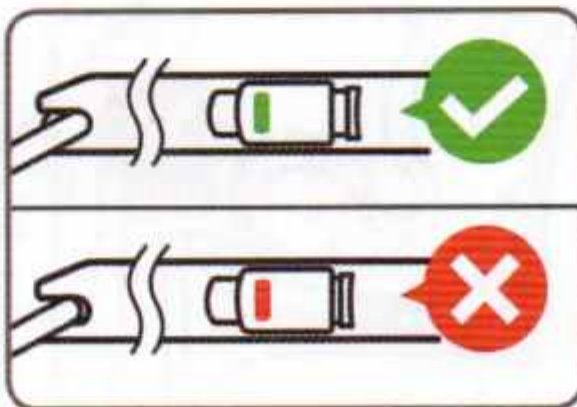

The colors of the indicators on both ISOFIX attachments should be completely green.

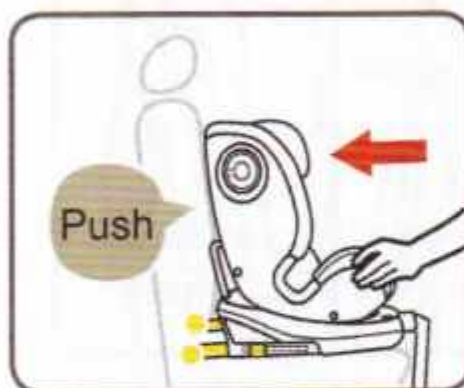

Push backrest of baby car seat to car seat tightly, make the length of ISOFIX to the shortest, then check by moving child seat back and forth if the baby car seat is fastness.

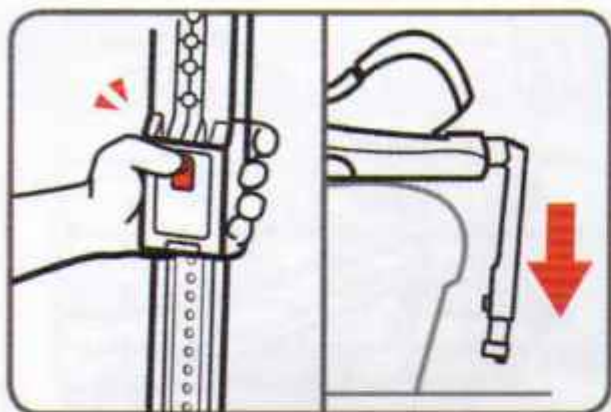

Press and hold the adjustment button of the support leg, extend support leg naturally to the length that can reach the ground

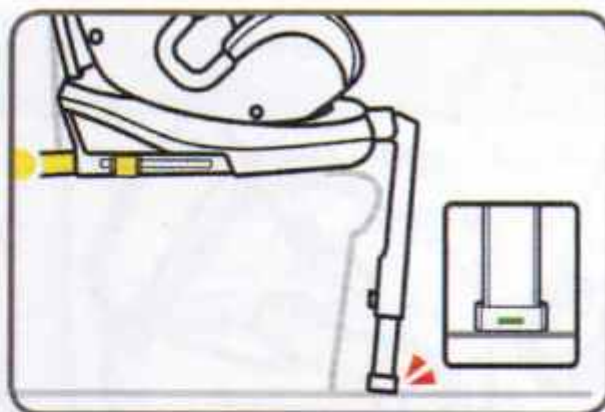

To keep support leg's bottom level same to the vehicle floor, it will display green color while the support leg be compress tightly



Check if the bottom of the safety seat fits the car seat to ensure there are no gaps.



Support leg angle should not exceed 90°, can not support on the raised ground.

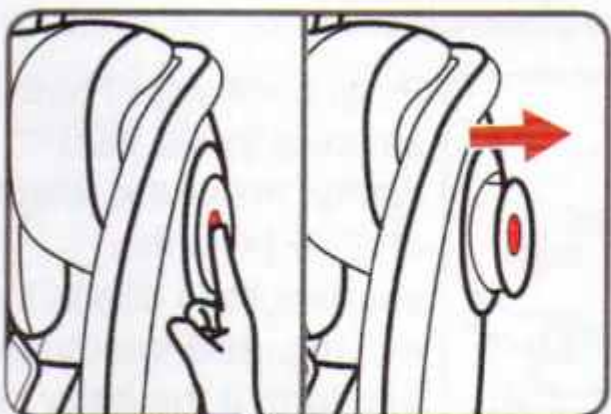

Press and hold the adjustment button to release the side protect system.

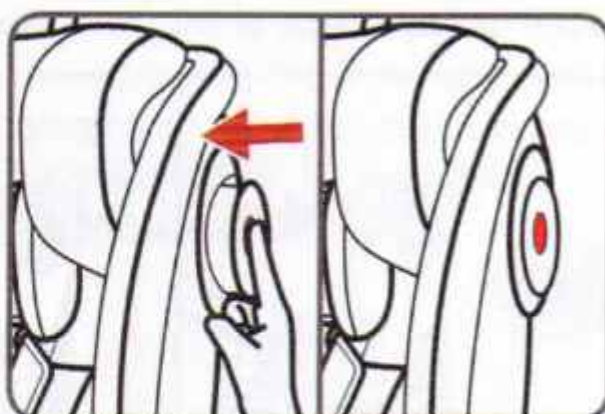

Press and hold the adjustment button, and push the side protect system inward. When the button is released, a "click" sound will prompt locking.

Use ISOFIX+support leg



1. Secure the safety seat to the car seat.
2. Rotate safety seat to the opposite direction of travel.
3. Fix the child occupant to the safety seat.

Rearward Facing:

Child height 40cm-105cm

Child weight ≤ 18 kg

Use ISOFIX + support leg

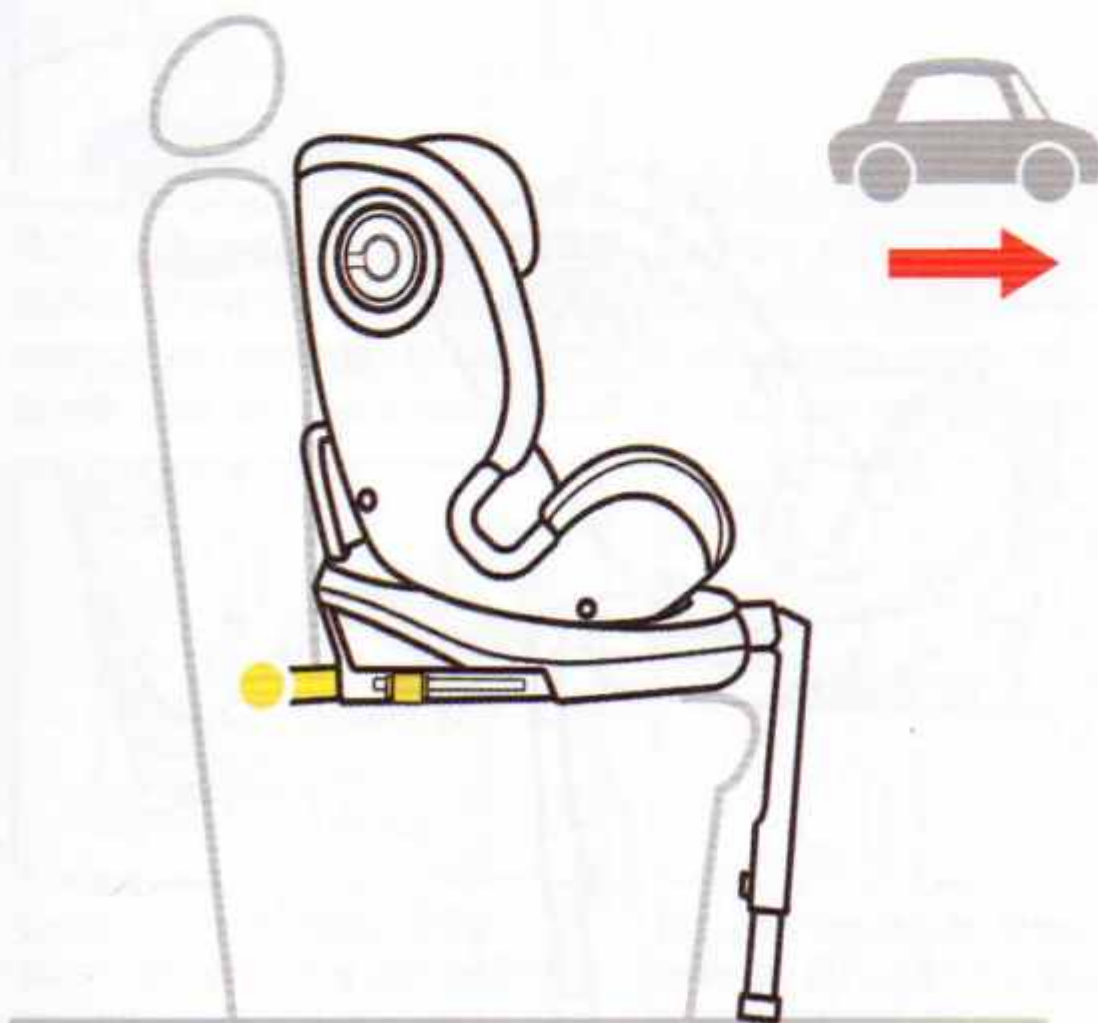

1. Secure the safety seat to the car seat.
2. Rotate safety seat to the direction of travel.
3. Fix the child occupant to the safety seat.

Forward Facing:

Child height 76cm-105cm

Child weight ≤ 18 kg

Using 5 point harness to fix child

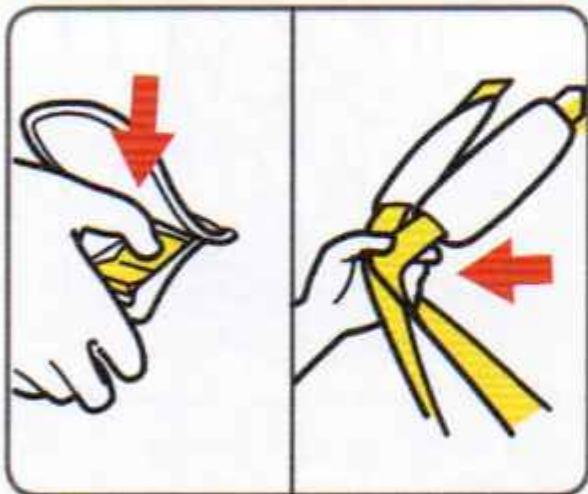

While pressing the harness adjustment button, pull completely the two shoulder harnesses of the child restraint.



Place the child in the child restraint and pass both arms through the harnesses.

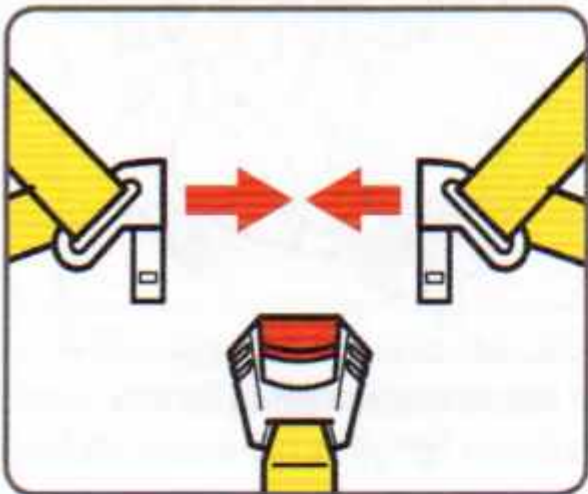

Important: The left and right bolts of the 5-point safety seat buckle are combined first.

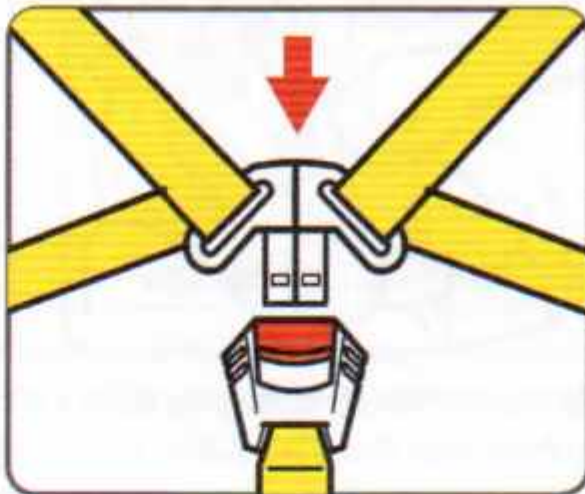

Engage the buckle as pictures show.



One side of 5-point safety seat buckle was locked is not allowed.

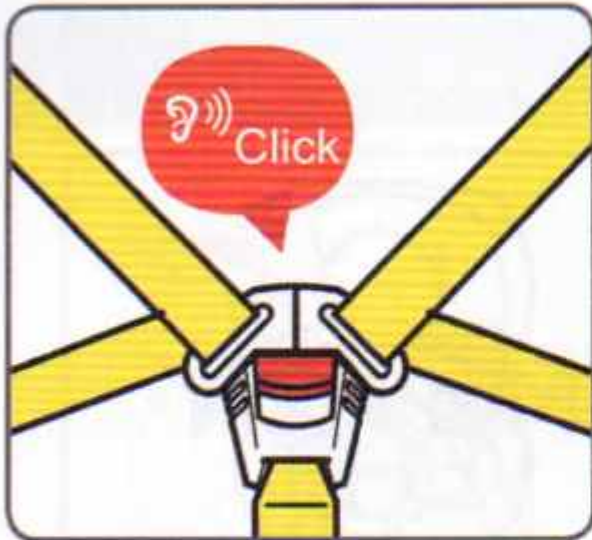

Make sure the buckle is properly engaged.

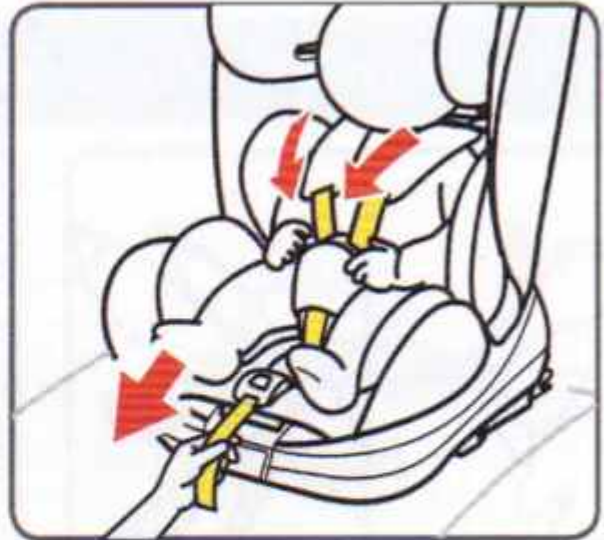

Pull the retractor belt to the right tightness.

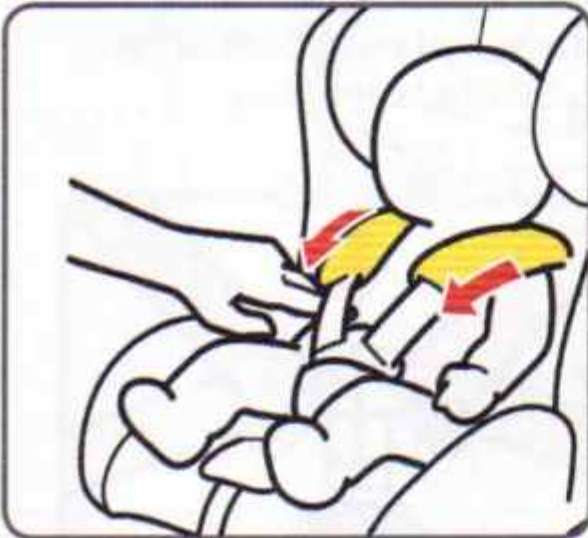

Make sure the space between the child and the shoulder harness is about the thickness of two fingers.

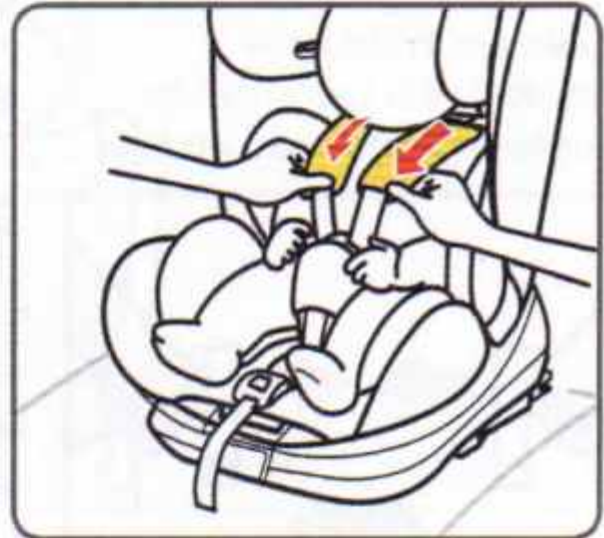

Pull the shoulder pads to the maximum length until it can not be pulled.

The style of the buckle may vary, depending on the actual receipt.



Warning:

Over-relaxed seat belts are not conducive to protecting children's safety.

ChelinoBaby®

Stores: ChelinoBaby – Ormonde – JHB
ChelinoBaby – Fourways – JHB
ChelinoBaby – Woodmead Square – JHB
ChelinoBaby – Greenstone – JHB
ChelinoBaby – Centurion – Pretoria
ChelinoBaby – Menlyn – Pretoria
ChelinoBaby – Kolonnade – Pretoria
ChelinoBaby – Gateway – Durban
ChelinoBaby – Cavendish Square – Cape Town
ChelinoBaby – Online – www.chelinobaby.co.za



Imported for :

ChelinoBaby Group of Companies,
No. 12 Kimberlite Road , Theta Ext 5 ,
Booyens Reserve , JHB , 2091. SA.
Tel: +2711 8352520
Info: info@chelinoplatinum.co.za

Installation with ISOFIX attachments+adult safety-belt

Forward Facing:

Child height 100cm-150cm

i-Size Booster seat

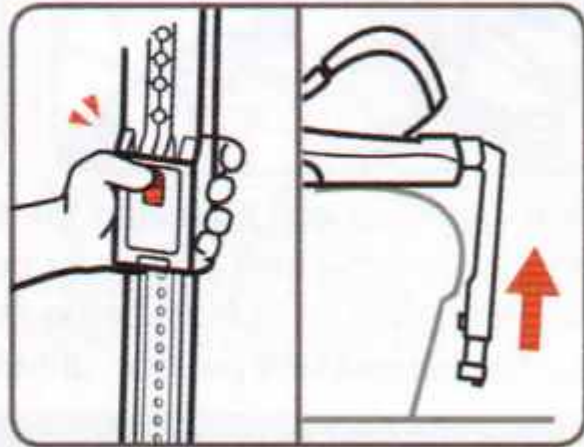

Shorten the support leg by pressing the support leg button.

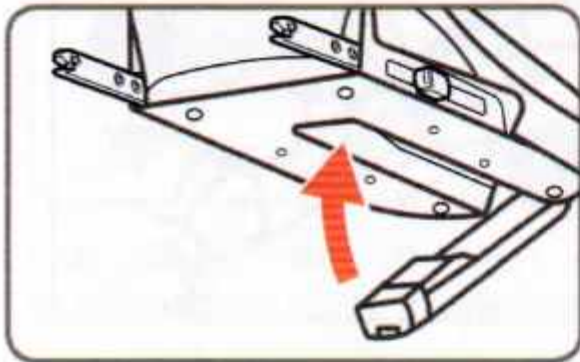

Fold the support leg into the seat base's storage slot, then push and fix it.



Rotate the seat to forward direction, Recline level adjust to level 1.



Install the ISOFIX interface then pull the car seat belt out.



Shoulder belt must pass through shoulder belt guide. Waist belt must pass through lap belt guidings.

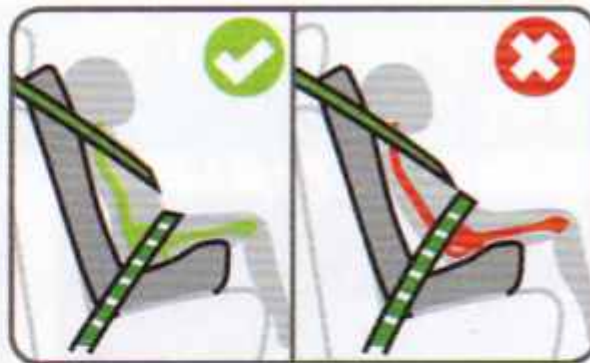
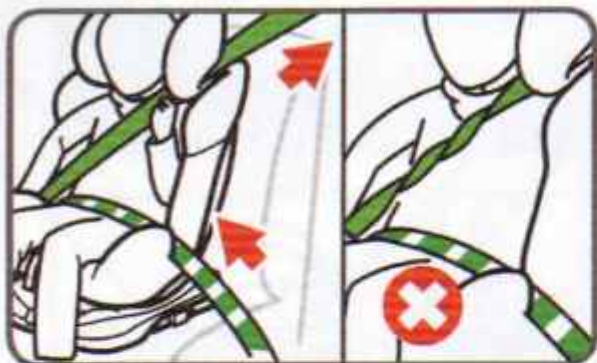

When installing and adjusting the safety belts, make sure that both the shoulder belt and waist belt are not twisted and will not keep the safety belts from being properly positioned.

Note the correct belt position should be above the child's pelvis.

Release ISOFIX

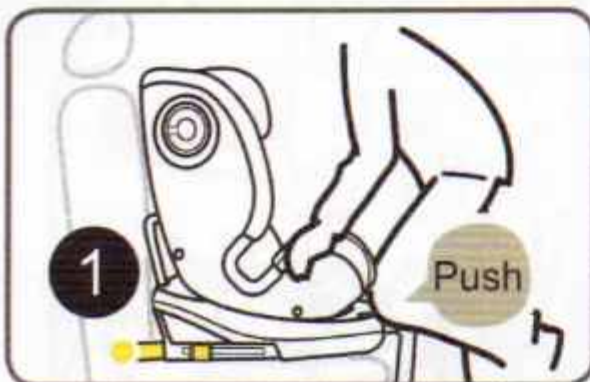

Prop up baby car seat with your knees.

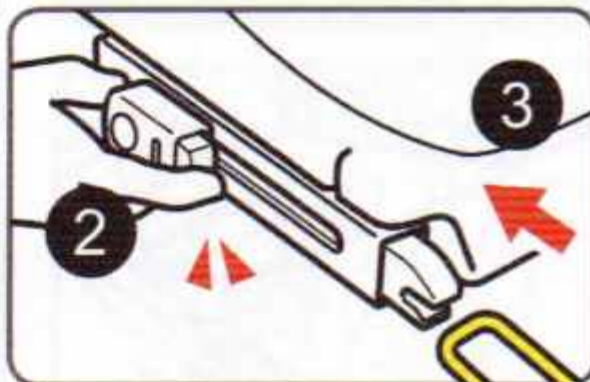

Pressing on release button and pull back to release the ISOFIX connector.

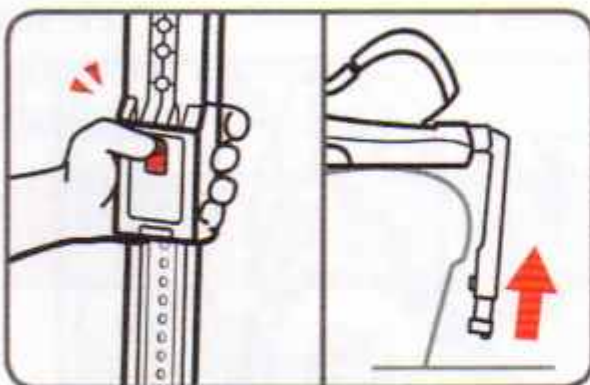

Shorten the support leg by pressing the support leg button.

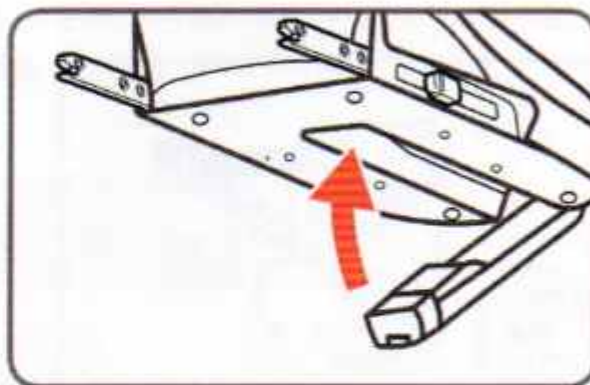

Remove the car seat, fold the support leg into the storage slot in the seat base.

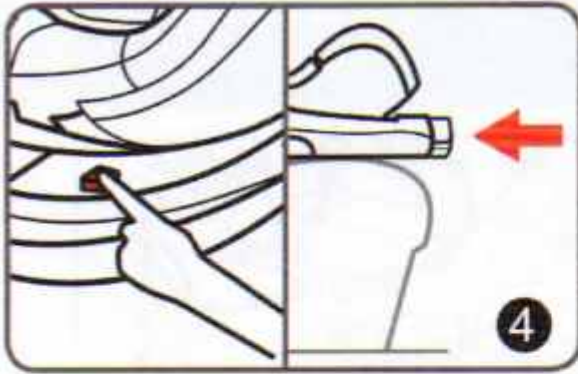

One hand press and hold the forward&backward adjustment button , the other hand push back the support leg.

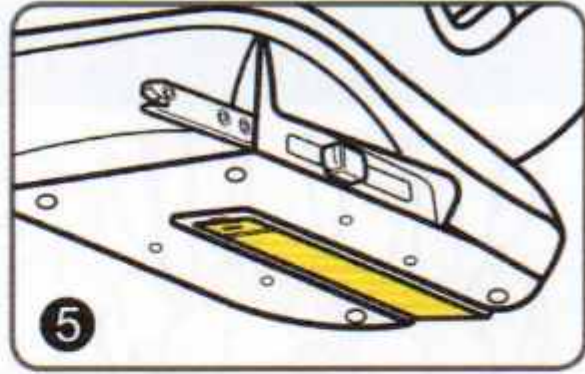

Fix the support leg all into the storage slot , if need released it , follow the opposite procedure.

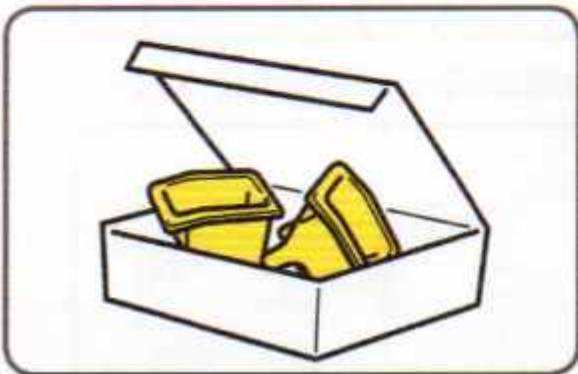

Keep ISOFIX attachments guides, please store it properly

⚠ Warning

NEVER install the product with car belt only. Please check the blue part in this page if you are failure to unblock the ISOFIX.

**Not brutal demolition
Avoid damage to parts**

Remove inner cushion and head pad.



Press the red button to release the 5-point buckle.

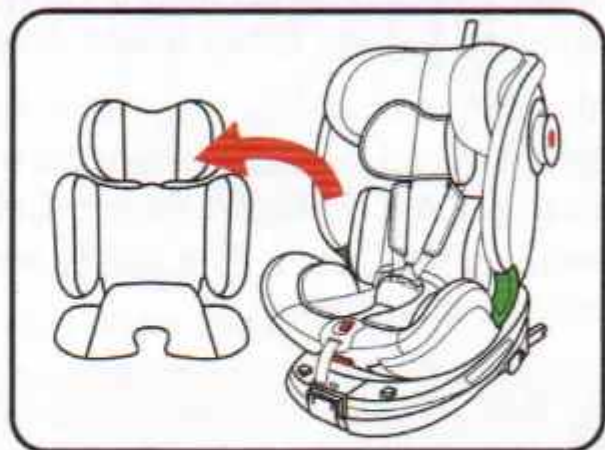

while children height is more than 75cm , remove all inner cushions.

▷ Recline adjustment

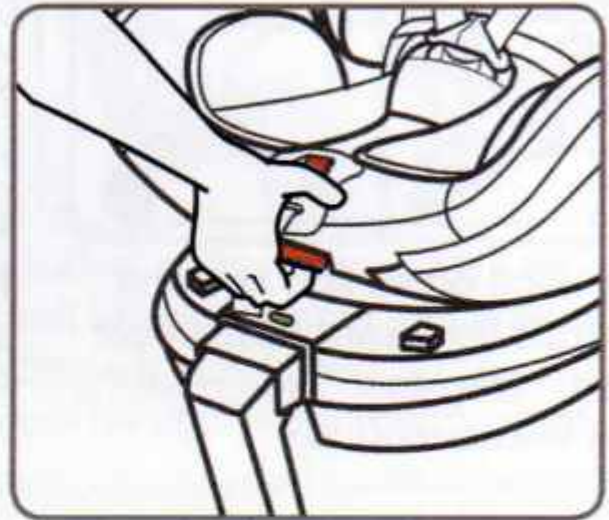
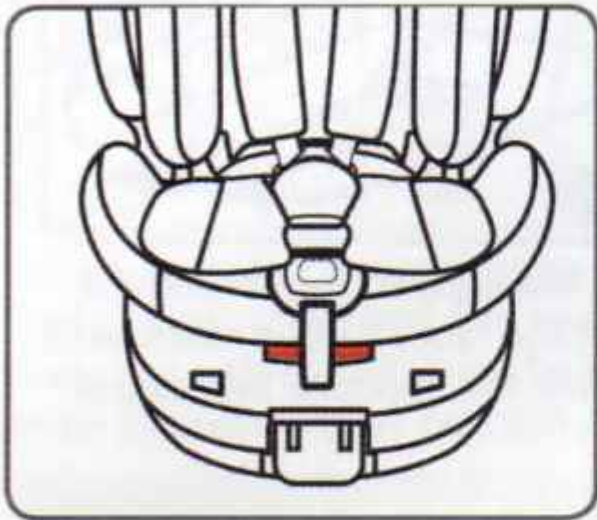

Find the red hand lever, pull it up to adjust the position.

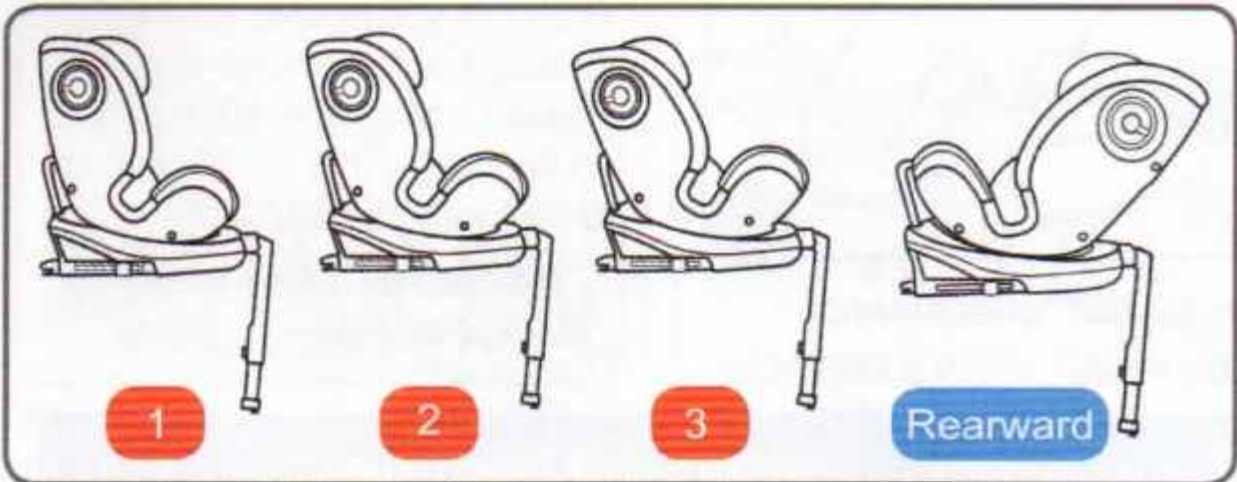

Forward Facing: Child height 76cm-150cm;

Rearward Facing: Child height 40cm-105cm/ Child weight≤18kg;

This safety seat have 3 positions for forward installation. Forward Facing: Child height 76cm-105cm could use position 1, position 2 and position 3. Forward Facing-Child height 100cm-150cm only could use position 1. The safety seat only provide one position for rearward installation.

⚠ IMPORTANT - DO NOT USE FORWARD FACING BEFORE THE CHILD'S AGE EXCEEDS 15 months (Refer to instructions)

▷ 5 point harness adjustment

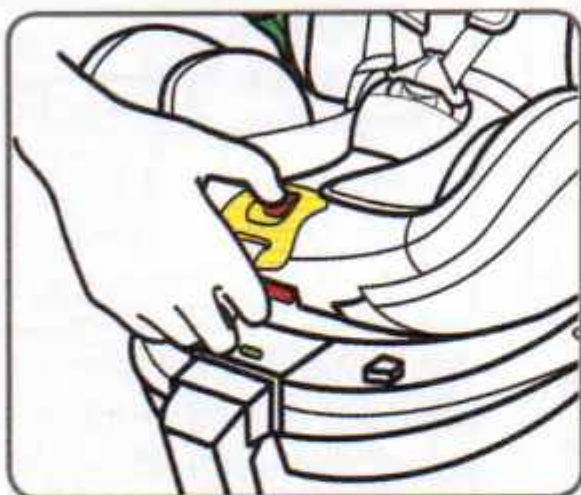

Adjusting the harness according to the current situation of child, make sure there no any twisting.

Pass the harness adjustment button

To loosen

To tighten

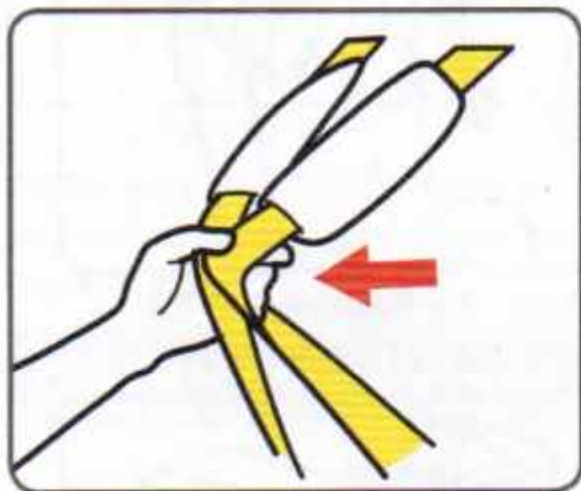

While pressing the harness adjustment button, pull completely the two shoulder harnesses of child restraint.

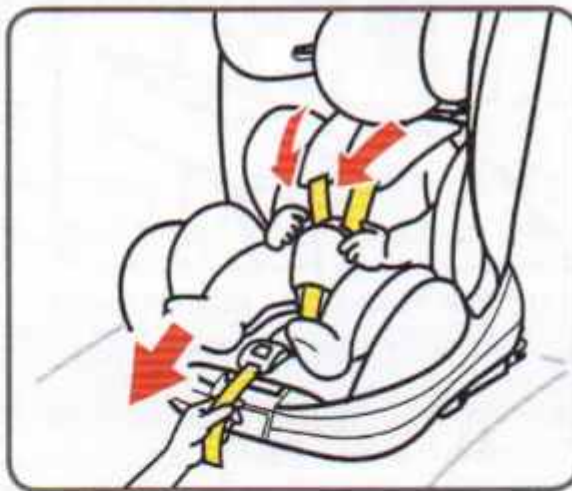

Pull down the adjustment webbing and adjust it to the proper length to make sure your child is snugly secured.

Head rest adjustment

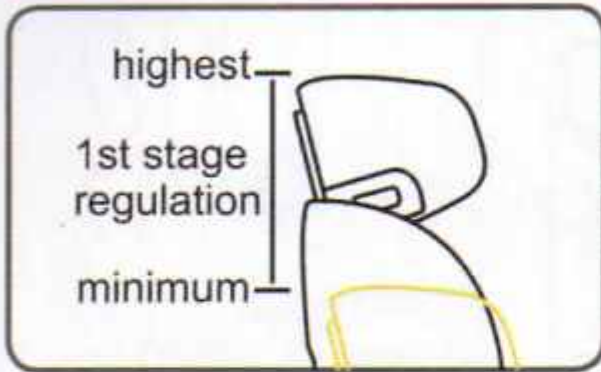

1st stage adjustment: use the headrest adjustment belt to adjust the height .



2nd stage adjustment: use the headrest adjustment button to adjust the headrest height. (only 1st stage adjust to the highest position , then the 2nd stage adjust can be operated)

Children's height is 40-135cm: Height adjustment method of headrest.



Pull up the headrest adjustment strap at the top of the headrest.

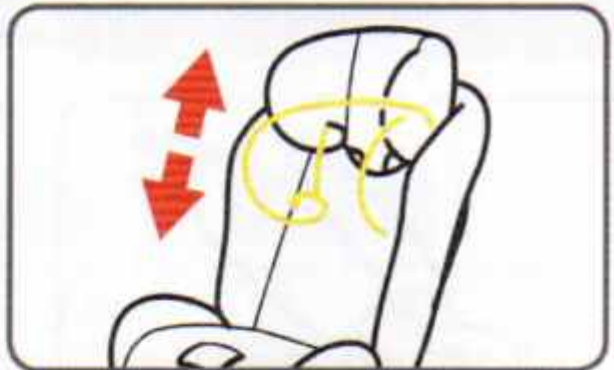

Adjust the headrest to the appropriate height.

⚠ WARNING

While baby's height is less 135cm. need to use the head restraint adjustment button, adjust the headrest to the lowest position of the 2nd adjustment.

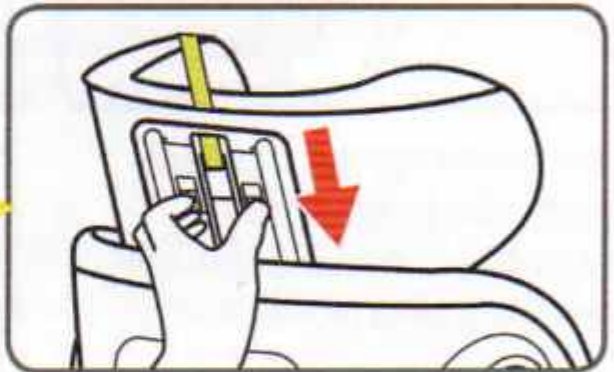

Children's height is 135-150cm: Height adjustment method of headrest.



Use the headrest adjustment belt to adjust the headrest to the highest position of the 1st stage.



Press and hold the headrest adjustment button to move the headrest to the appropriate height.

Checking the shoulder strap height

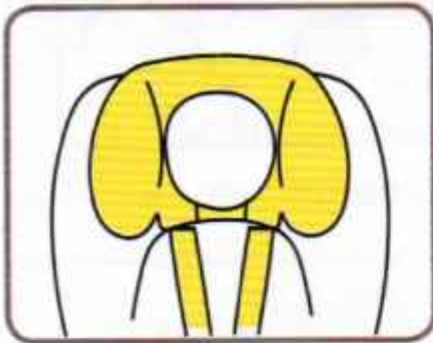

No-Too low

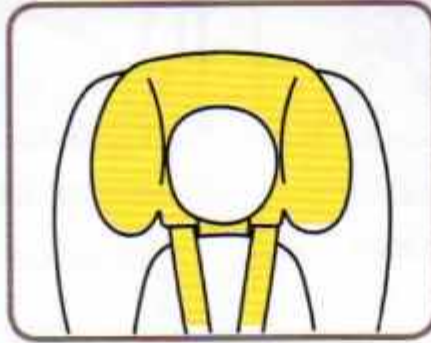

No-Too high

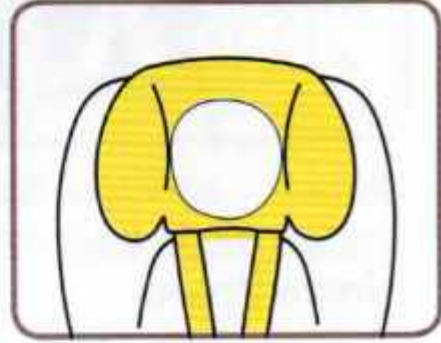

Yes-Correct

Make sure that the harness is on the same height as your child's shoulders. Otherwise, move the shoulder strap up or down to the correct slot.

Conceal the harness system (Suitable for child height 100cm-150cm)



Release the 5 - point buckle, pull up the headrest, turn up the back cushion.

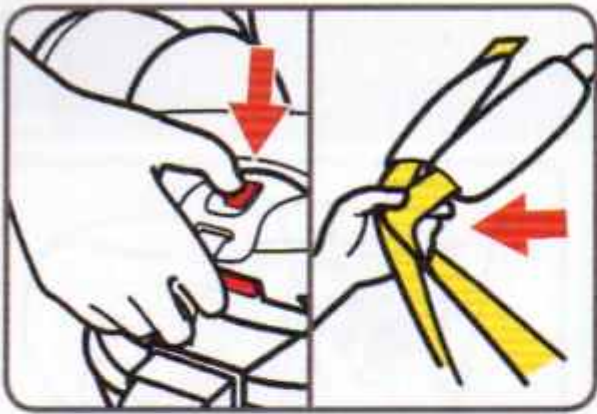

Press the harness adjustment button and loosen the straps.

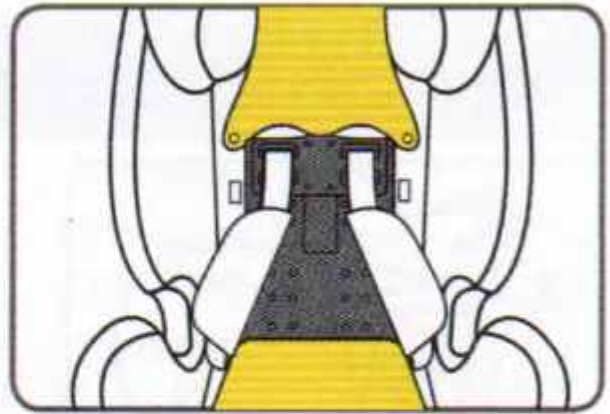

Lift the upper flap upward and pull the lower flap forward.

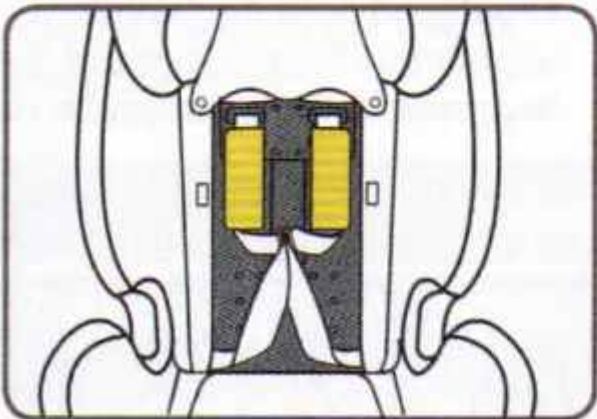

Store the shoulder harnesses and buckle in their storage compartments.



Remove the buckle bag.

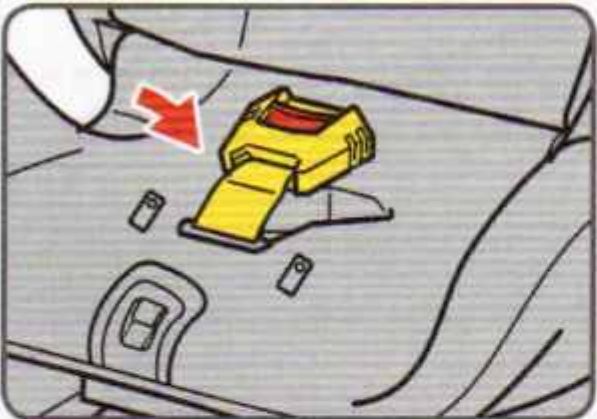

Pull the buckle to the back of the seat pad, and then store buckle and buckle tongues in respective storage compartments.

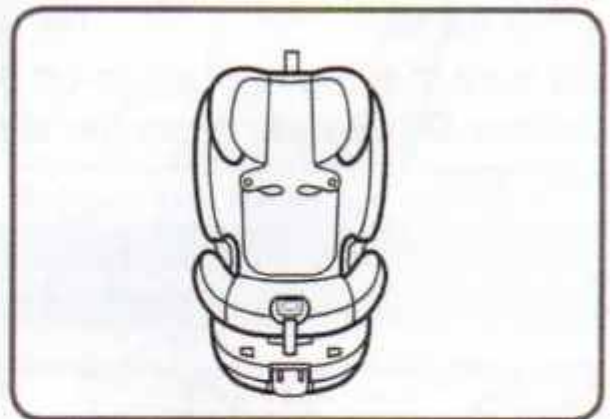

To reattach the snaps to recover the seat pad. The reassembled seat pad is shown as above picture.

Rotate/changing direction

Rearward Facing:
Child height 40cm-105cm
Child weight ≤18kg



For the convenience of children using. Can only be used when the car is stopped; **Prohibited after use of the car.**

Forward Facing:
Child height 76cm-150cm

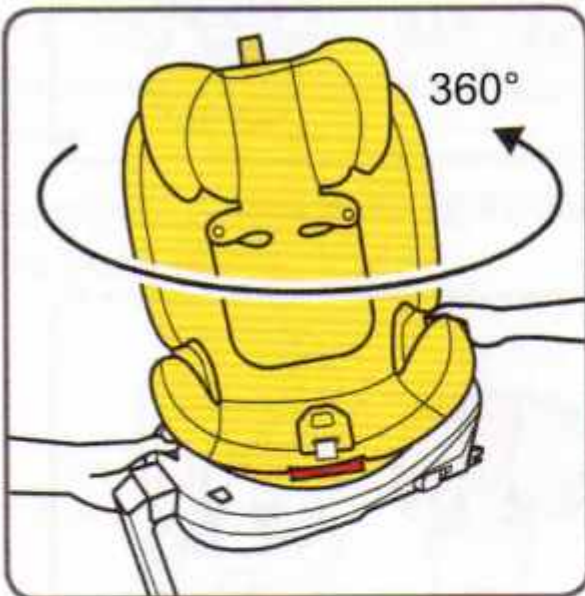

Press and hold the rotate button with one hand, and rotate the seat with another hand.



Released the rotate button while rotation, it will be locked while its in the Forward and backward positions , with a "Click" sound.

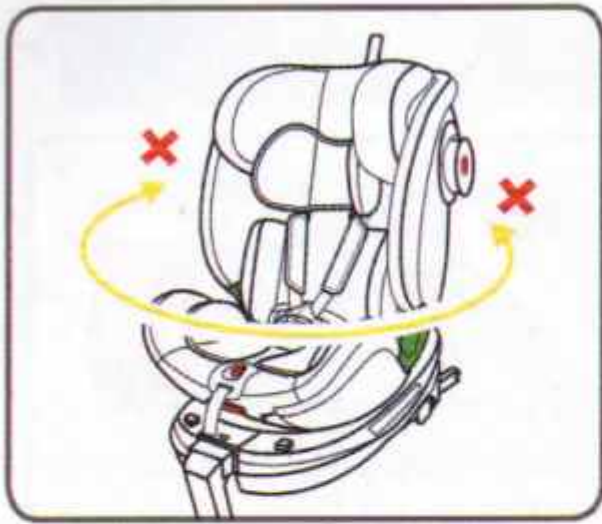

Confirm safety seat is fixed tightly by shaking or rotating seat.



Warning
Never use any unblock direction, fixed direction before using.

Detach soft goods

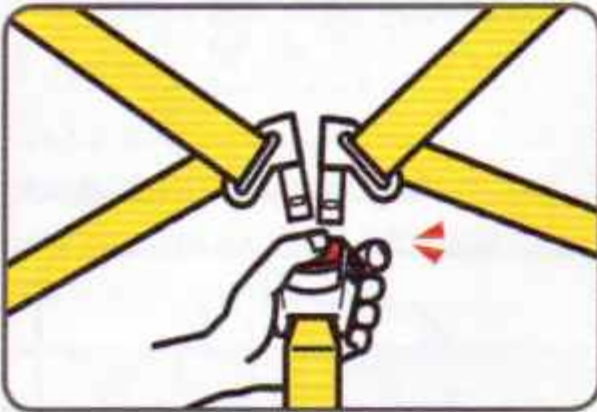

Press the red button to disengage the buckle.

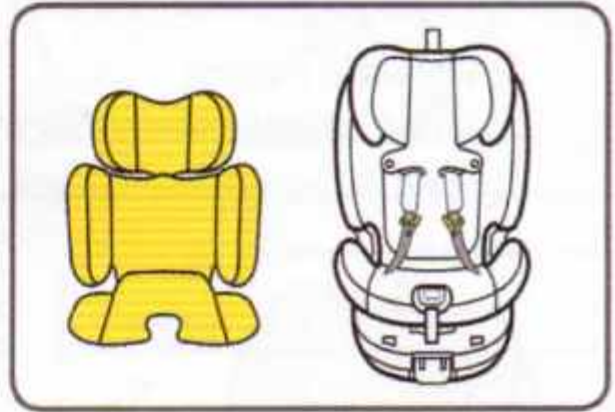

Remove all inner pad.



Remove the buckle pad, conceal the buckle in the buckle hole on the seat base.

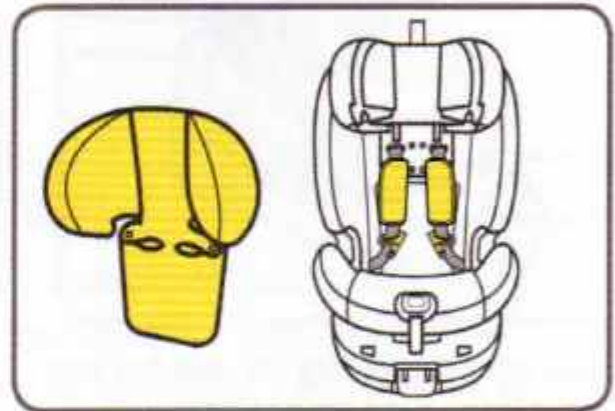

Remove the headrest cloth cover.

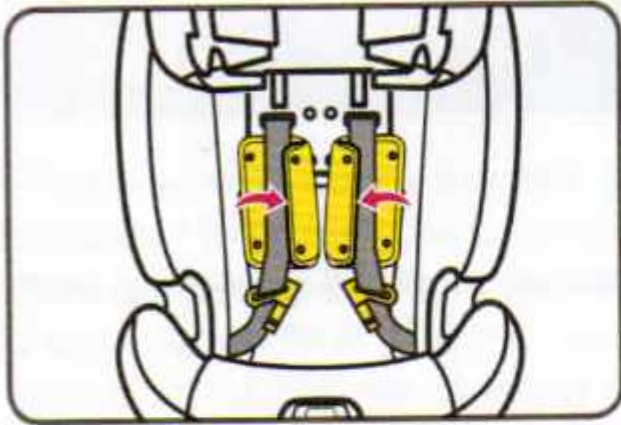

Loosen all fixing buttons on the shoulder pad sleeve.

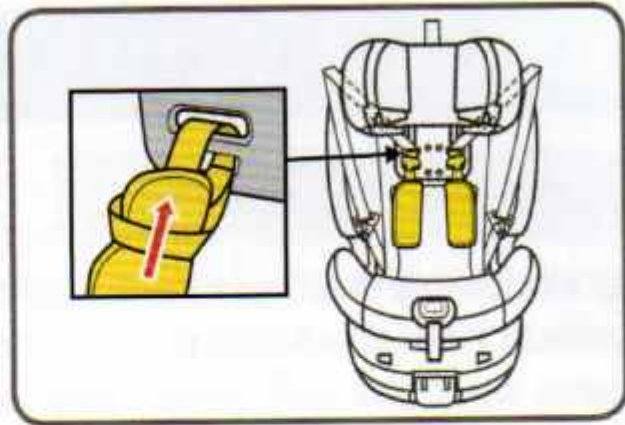

Pull up to take the shoulder pad out from the hole.

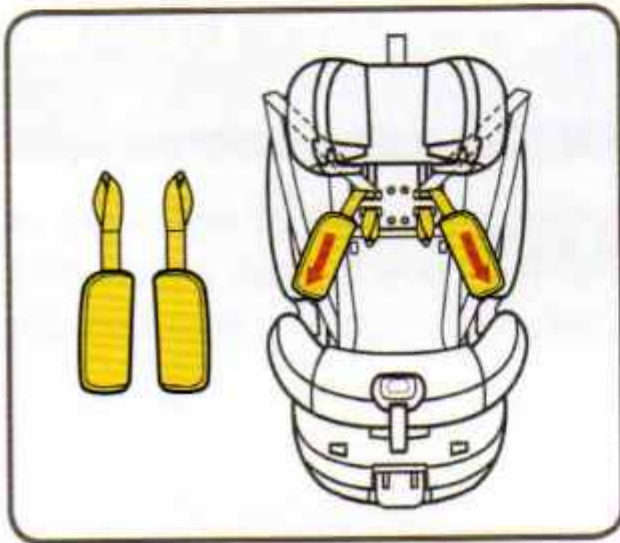

Pull down to take shoulder pad out. Lower the headrest cloth cover.

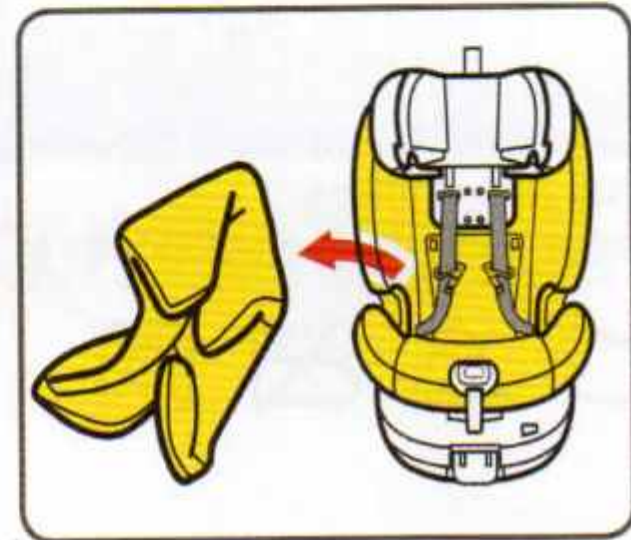

Remove the cloth cover all seats.

Seat cloth cover mounted: To assemble soft goods ,reverse the steps above.

Maintenance

Safety seat maintenance

After removing foam of infant insert, please store it somewhere that the child can not access it.

-Please wash the soft goods with cold water under 30°C.

-Do not iron the soft goods.

-Do not bleach or dry clean the soft goods.

-Do not use undiluted neutral detergent, gasoline or other organic solvent to wash the child restraint. It may cause damage to child restraint.

-Do not twist the goods to dry with great force, it may leave the soft goods with wrinkles.

-Please hang dry the soft goods in the shade.



Warning

Child restraint system (safety seat) without cloth cover can not be used.



Safety seats save.

Please always check the seat parts are complete, the seat is in good condition to reduce the chance of accidents.

Please remove the child restraint from the vehicle seat if not in use for a long period time. Put the child restraint in the shade and somewhere your child can not access it.

Please do not leave the seat in a cold or hot, humid enviroment for long periods of time.

Please keep this instruction well for checking.

Post-accident treatment

In the event of a violent collision and accident, please replace it with a new seat. If you have any other questions, please contact the distributor or manufacturer.