

 cybex
GOLD

ZENO





INSTRUCTIONS !
MANUEL !
ANLEITUNG !
INSTRUCCIONES !



+



WARNINGS !
MISES EN GARDE !
WARNHINWEISE !
ADVERTENCIAS !



Max. 1



Max. 22 kg / Max. 49 lb



Max. 34 kg / Max. 75 lb



Max. 111 cm / Max. 44 in



6 m - 4 y



Max. 0,5 kg
Max. 1.1 lb



Max. 1 kg
Max. 2.2 lb







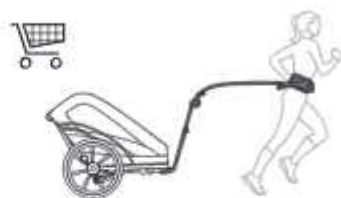

Max. 2 kg
Max. 4.4 lb











4 bar (min. 3,5 - max. 5,9 bar)
58 psi (min. 50 - max. 85 psi)











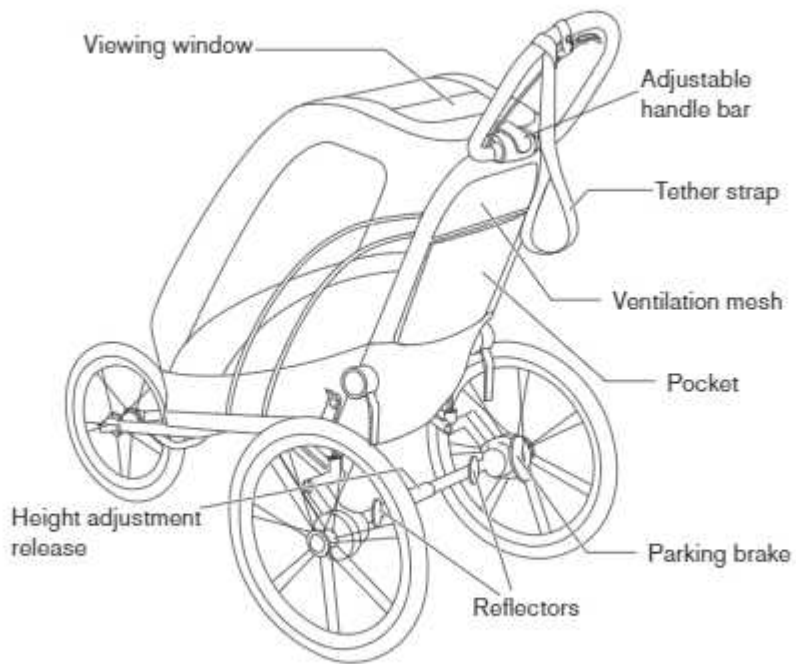



	Product overview	8
	Tutorial video	22
	Preparing the product	23
	Attaching the fabrics	32
	Using the parking brake	43
	Adjusting the cabin height	44
	Adjusting the handle bar	45
	Using the tether strap	46
	Using the hand brake	46

	Using the harness	47
	Using the mesh cover	51
	Using the weather cover	52
	Using the sun shield	53
	Adjusting the track	54
	Folding	55
	Removing the wheels	58
	Removing the fabric	61











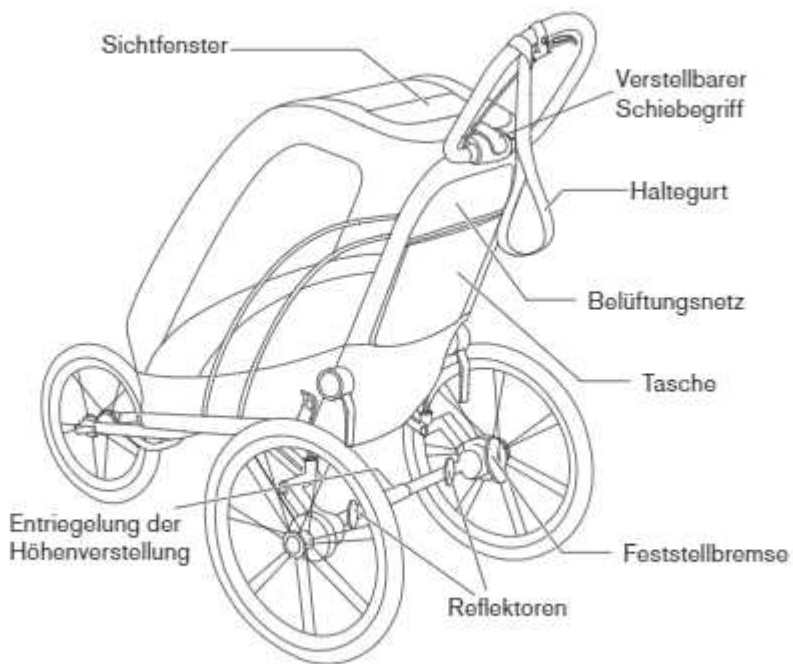











	Produktübersicht	12
	Videoanleitung	22
	Vorbereitung des Produktes	23
	Anbringen des Sitzbezuges	32
	Benutzung der Feststellbremse	43
	Verstellung der Kabinenhöhe	44
	Verstellung des Schiebegriffs	45
	Benutzung des Haltegurts	46
	Benutzung der Handbremse	46

	Verwendung des Gurtsystems	47
	Verwendung des Meshverdecks	51
	Verwendung des Wetterverdecks	52
	Verwendung des Sonnenverdecks	53
	Verstellung der Spur	54
	Faltung	55
	Entfernung der Räder	58
	Abnahme der Bezüge	61











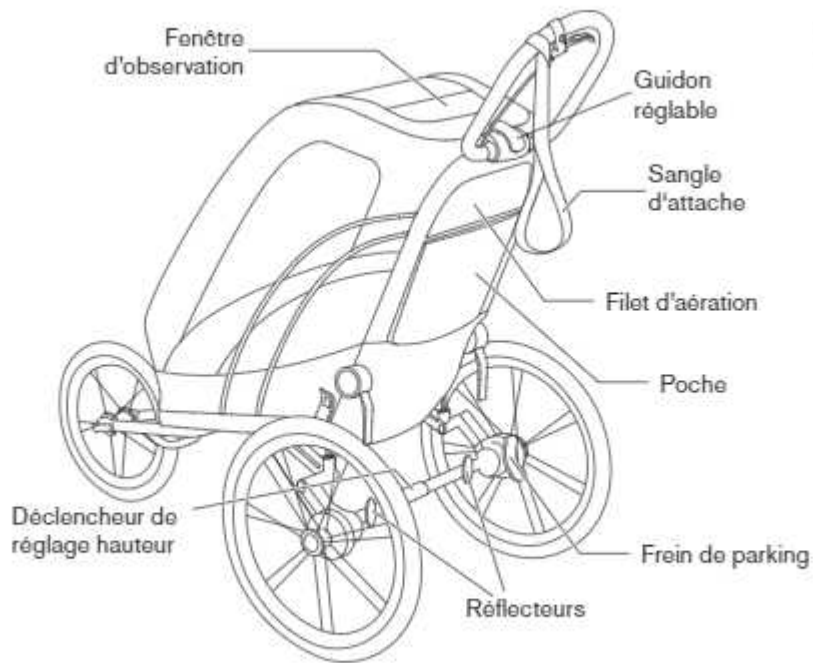











	Vue d'ensemble du produit	16
	Tutoriel vidéo	22
	Préparation du produit	23
	Attachez le tissu	32
	Utilisation du frein de parking	43
	Ajustement de la hauteur cabine	44
	Réglage du guidon	45
	Utilisation de la sangle d'attache	46
	Utilisation du frein à main	46

	Utilisation du harnais	47
	Utilisation de la couverture mesh	51
	Utilisation de la couverture météo	52
	Utilisation Pare-soleil	53
	Ajustement de l'alignement	54
	Pliant	55
	Retrait des roues	58
	Retirer la housse	61





	Vista general del producto	20
	Video tutorial	22
	Preparación del producto	23
	Colocación de la funda del asiento	32
	Uso del freno de estacionamiento	43
	Ajuste de la altura de la cabina	44
	Ajuste del manillar	45
	Uso de la correa de sujeción	46
	Uso del freno de mano	46

	Uso del sistema de arneses	47
	Uso de la cubierta de malla	51
	Uso de la cubierta del clima	52
	Uso del protector solar	53
	Ajuste de la dirección	54
	Plegado	55
	Extracción de las ruedas	58
	Retirada de las fundas	61

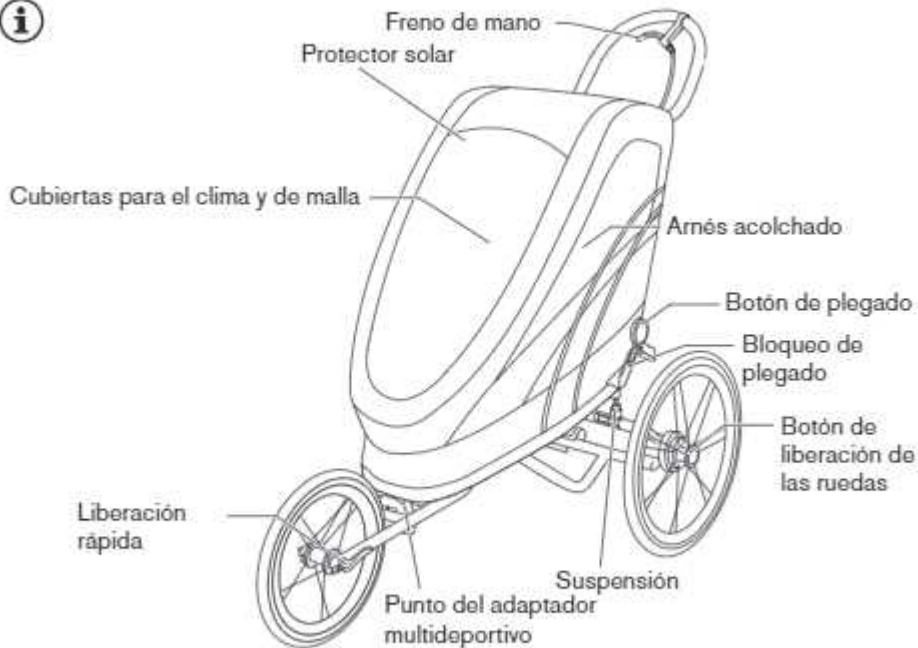

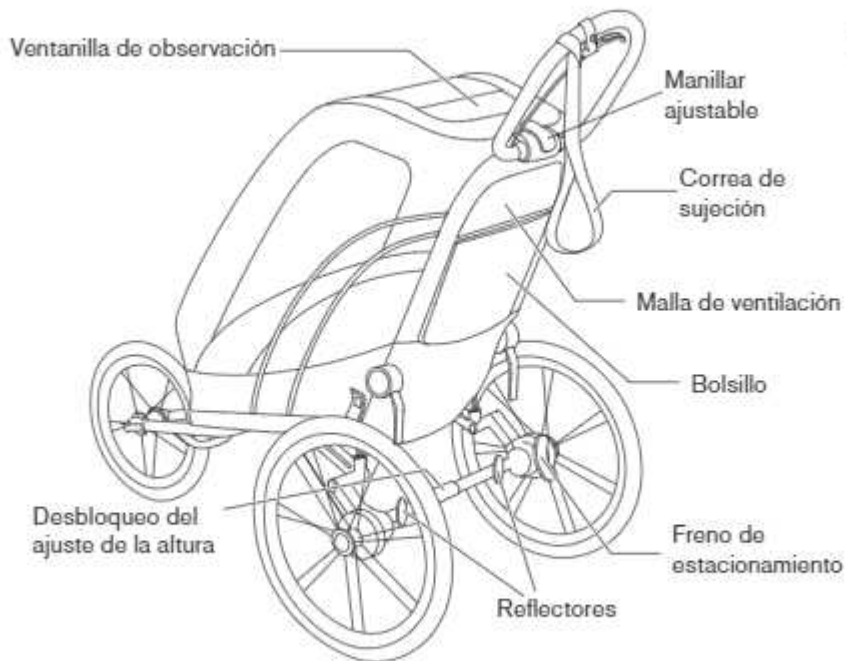



tutorial video
Videoanleitung
tutoriel vidéo
video tutorial



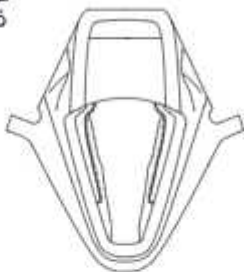
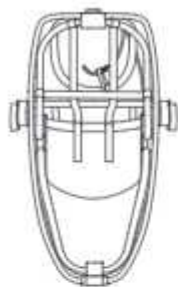

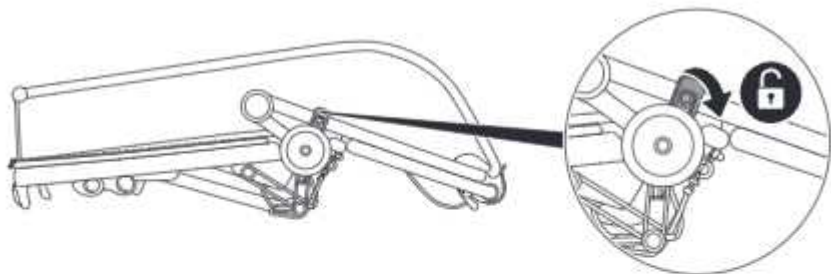

2

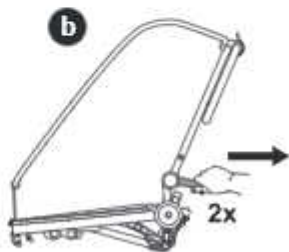

3

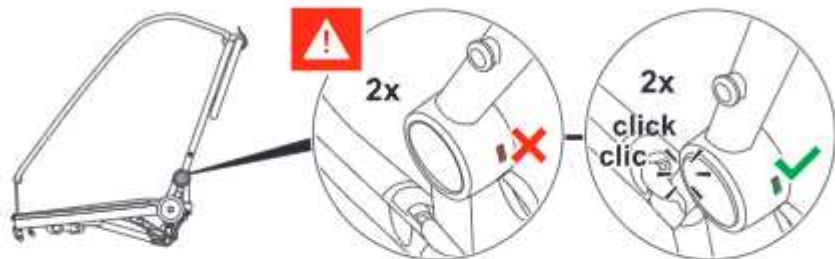

4



25

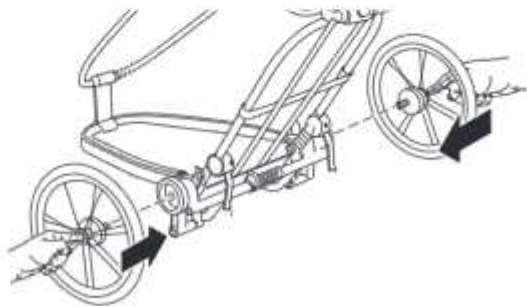

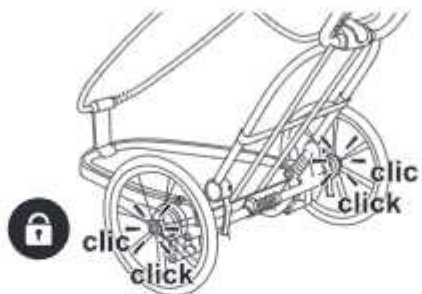

8

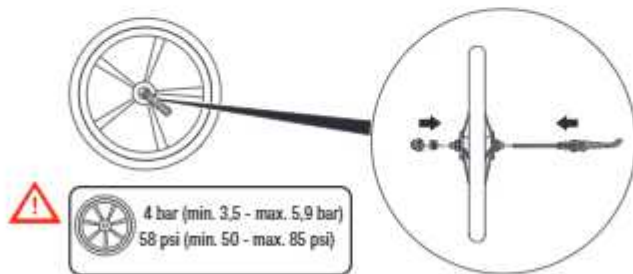

9

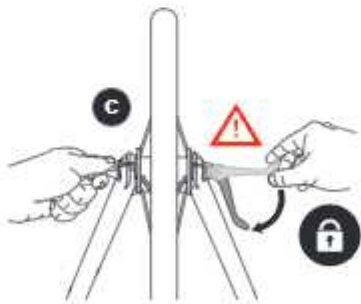
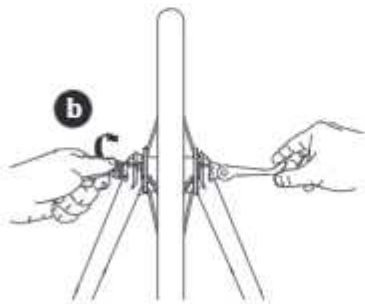
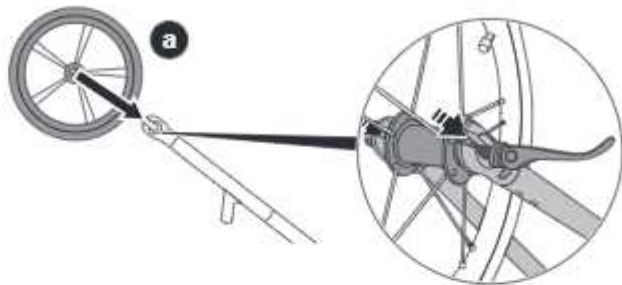



11

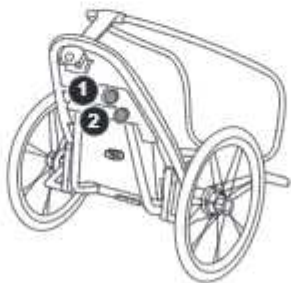

12

29

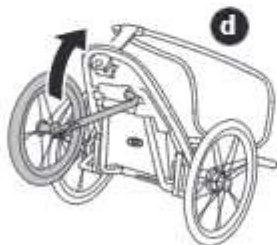
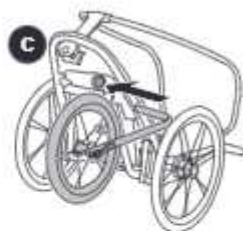
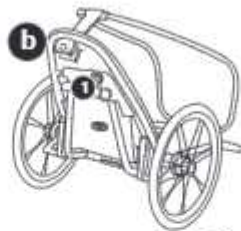
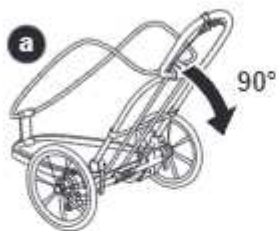

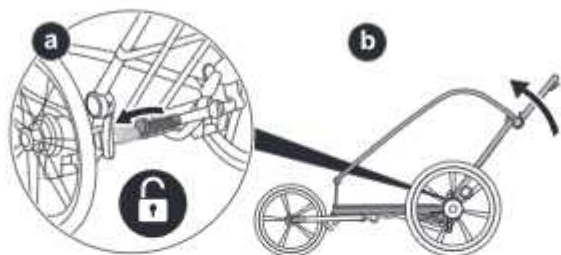



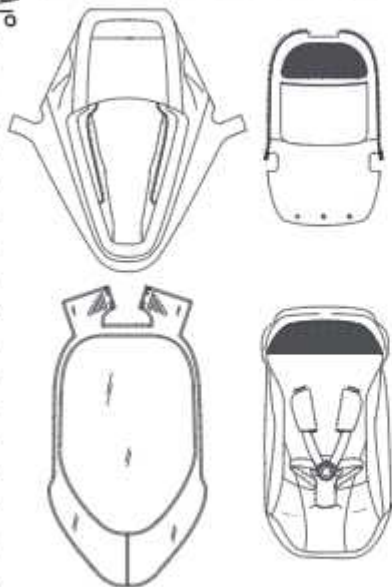



3

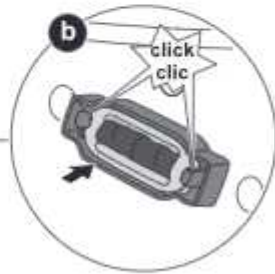
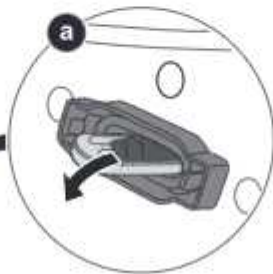

4

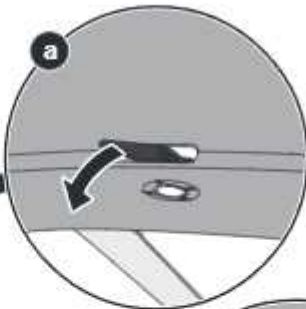
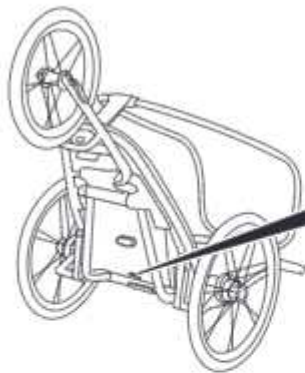

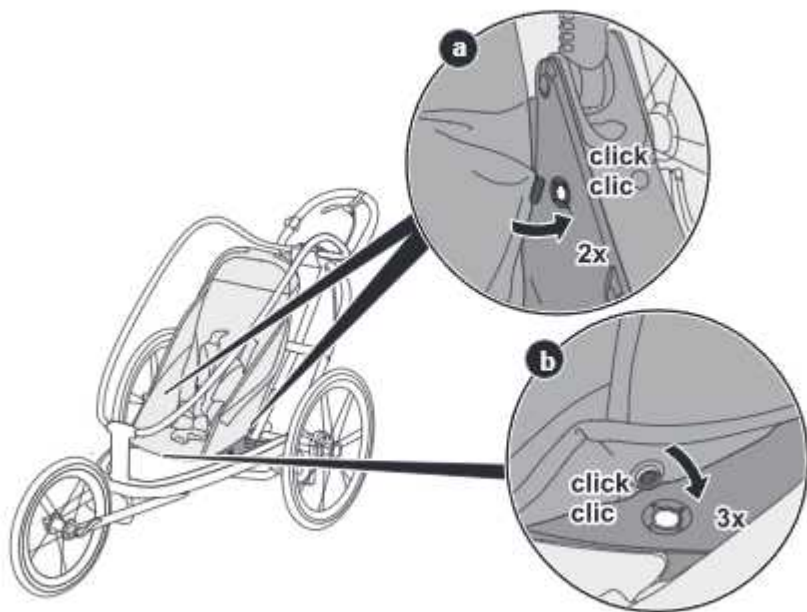

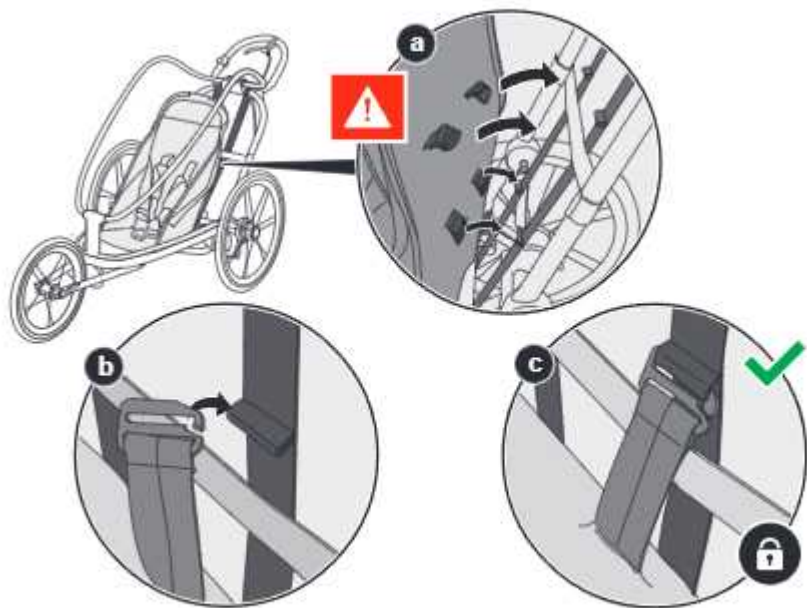



B



B

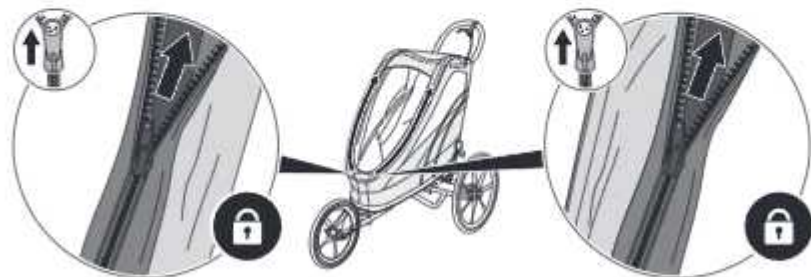
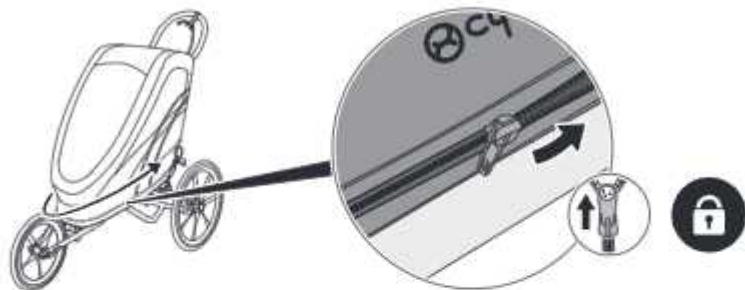

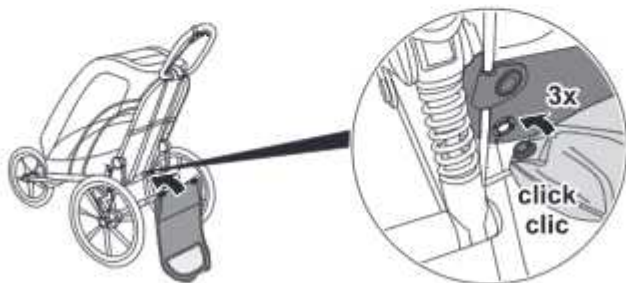
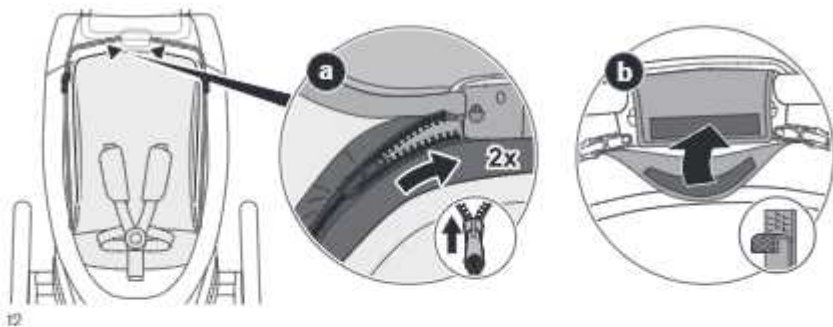

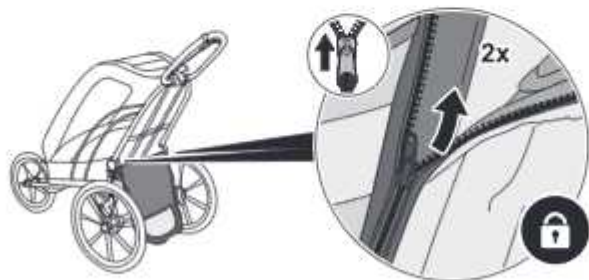
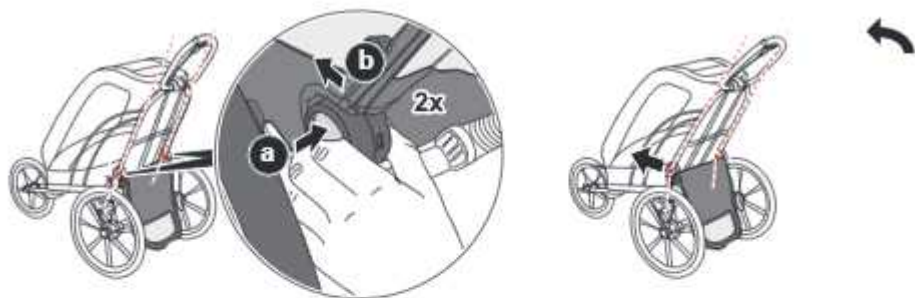



16

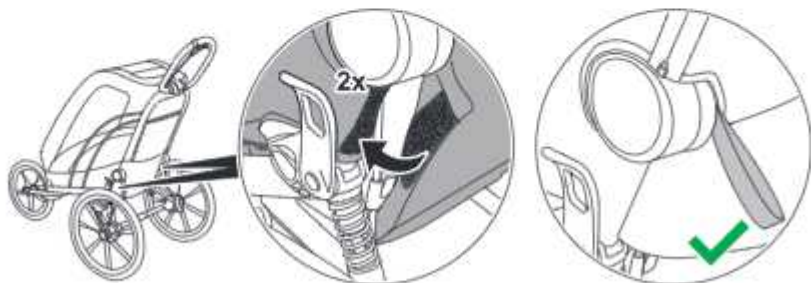

17

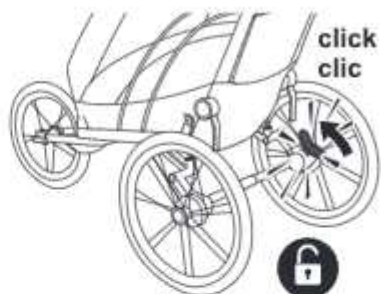
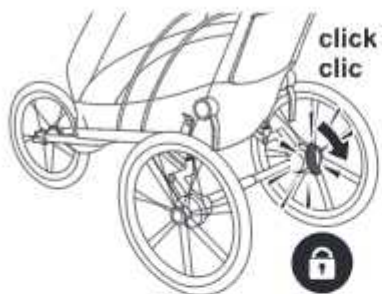

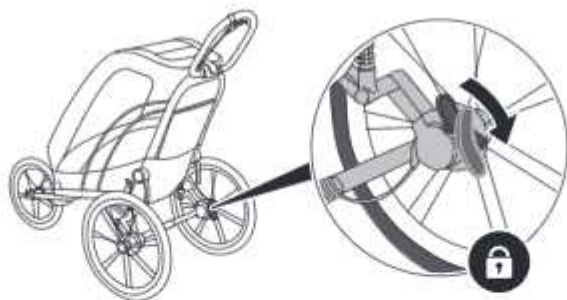

1



2



a

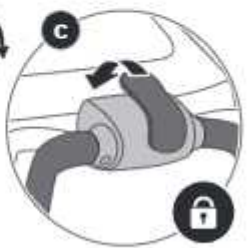
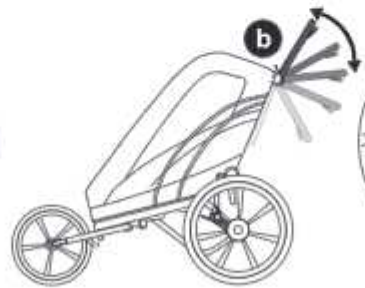

r

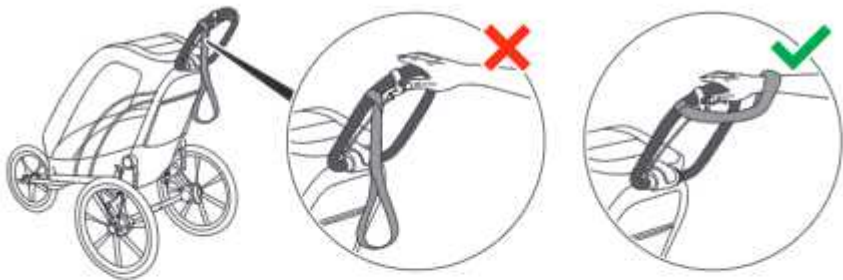

1



1

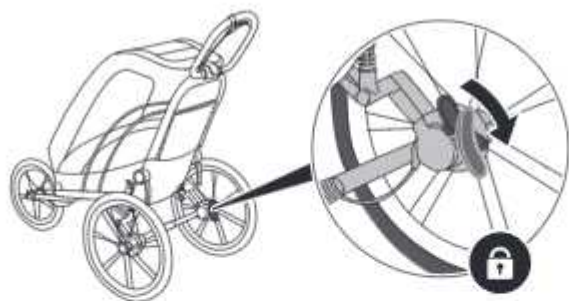

1

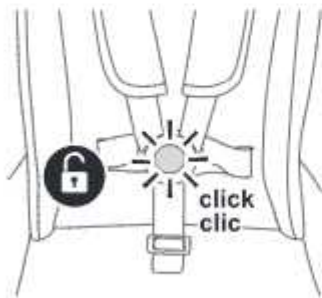

2

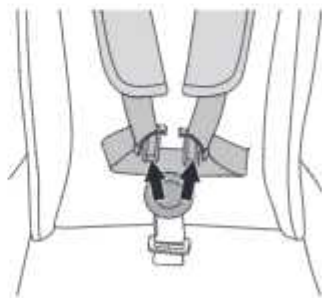

3

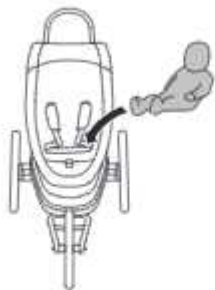

4

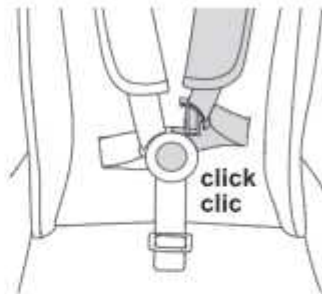

5

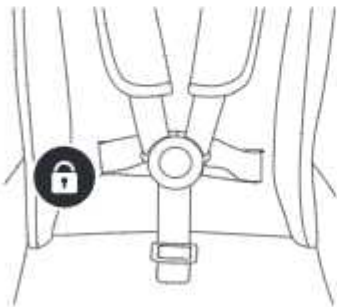

6

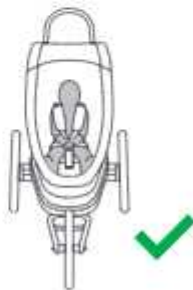

7

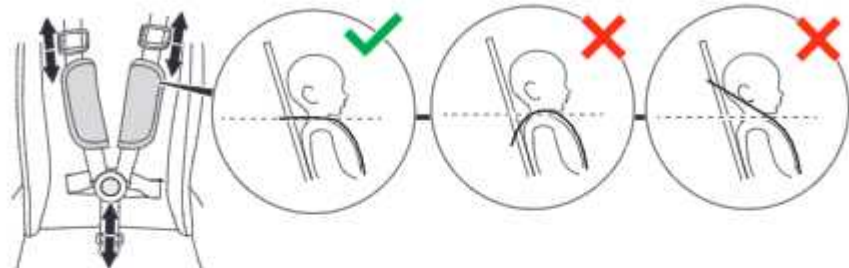

8

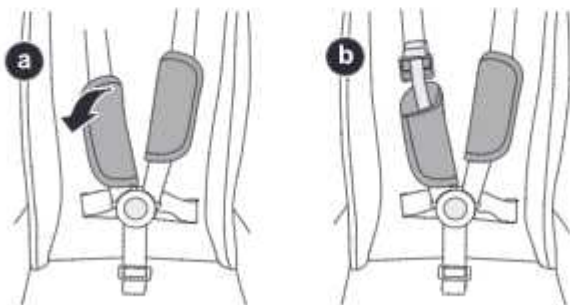

9



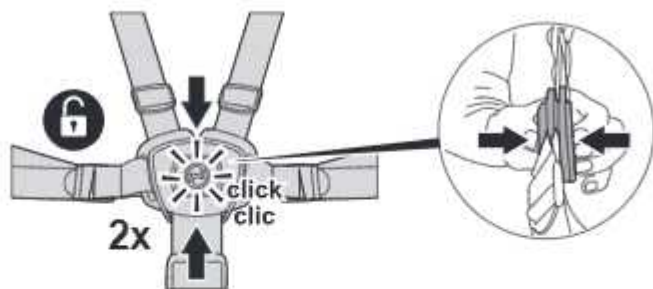

1

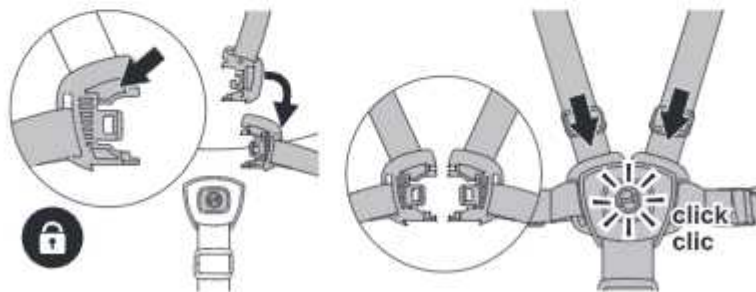

2



1

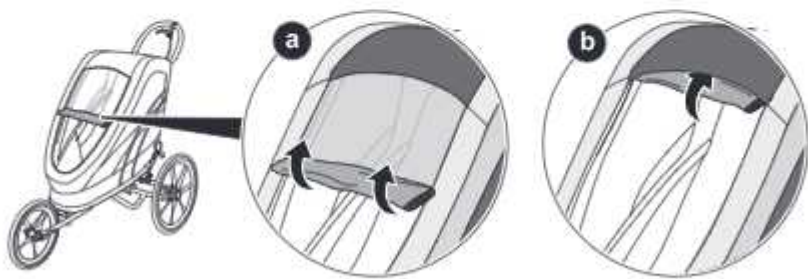

2

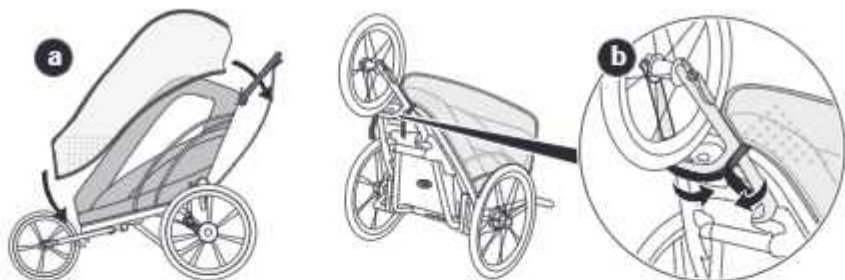

1

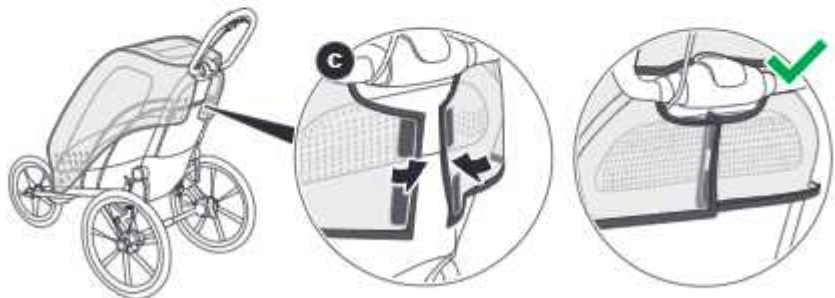

2

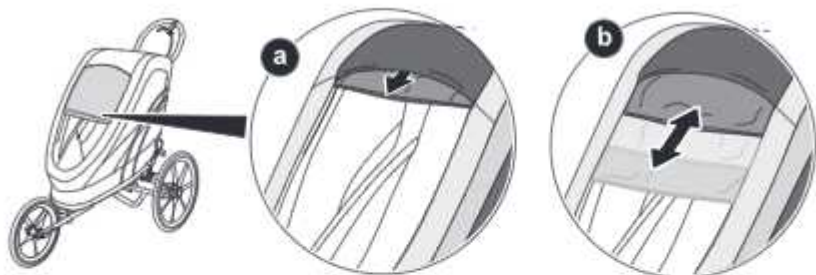

1



2

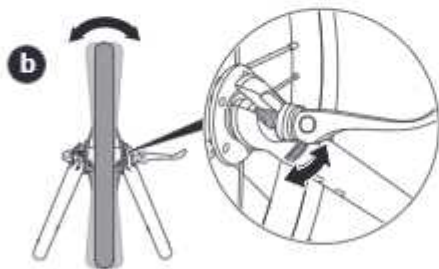
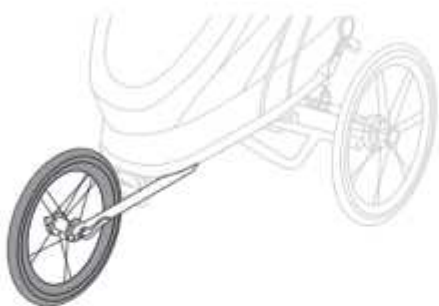

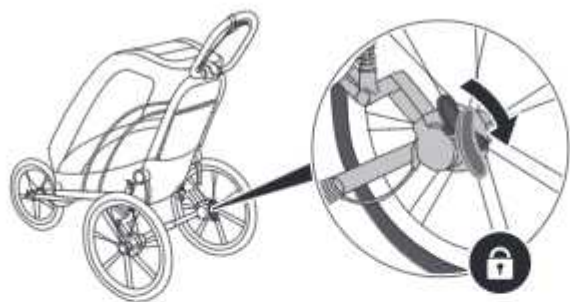

1

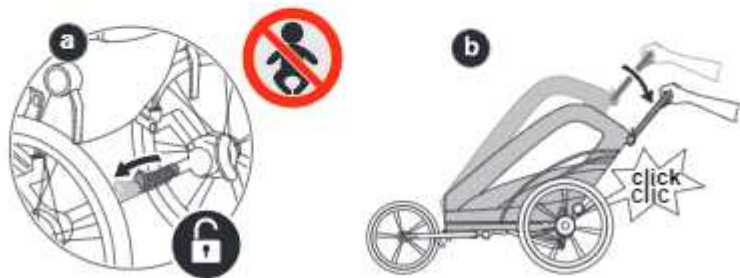

2

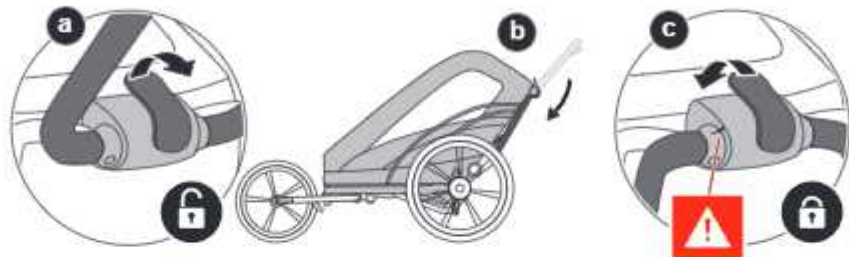

a

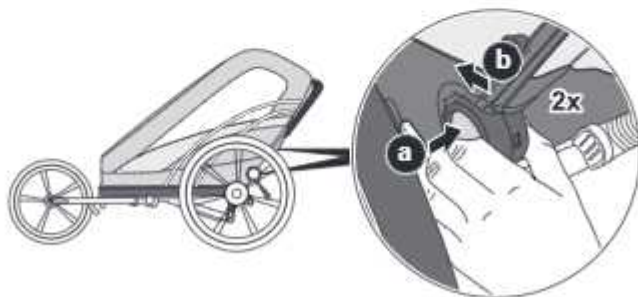

4

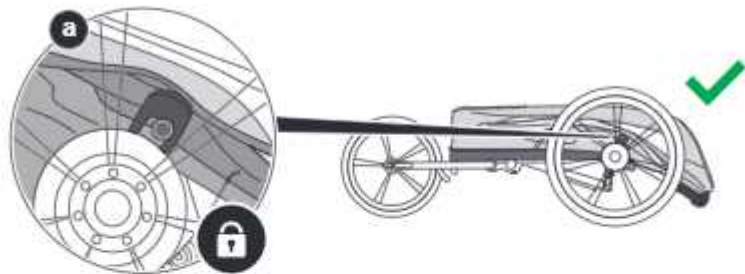

5

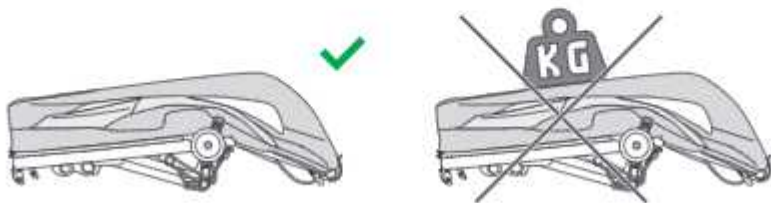

6

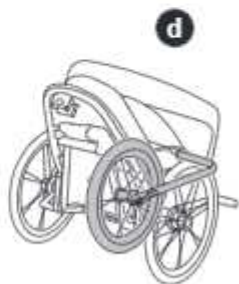
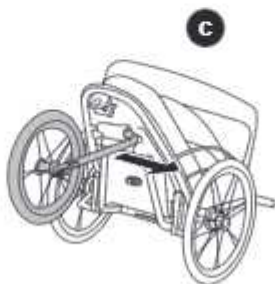
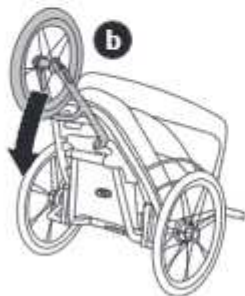
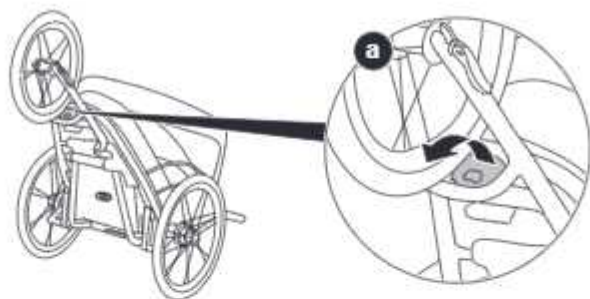

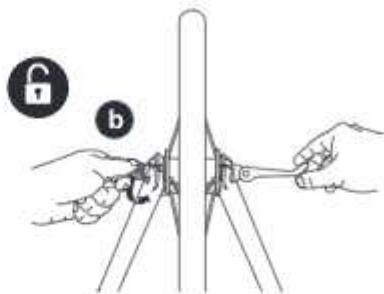
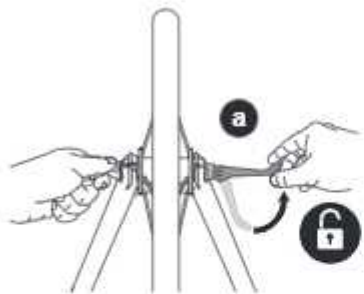

2



3



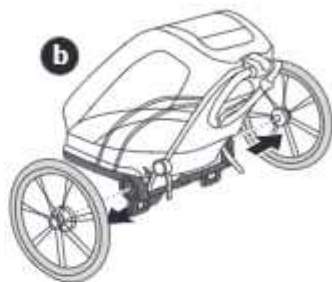
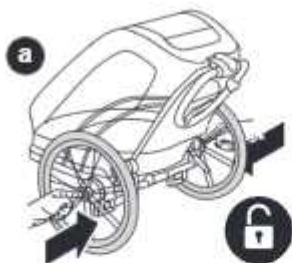

4

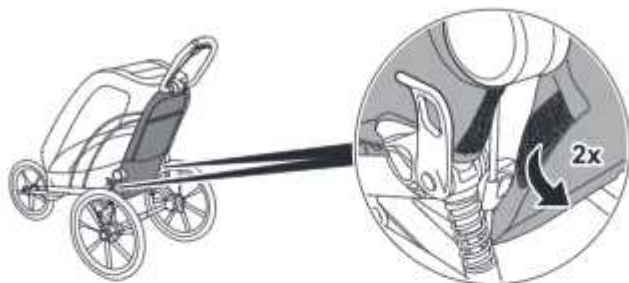

1

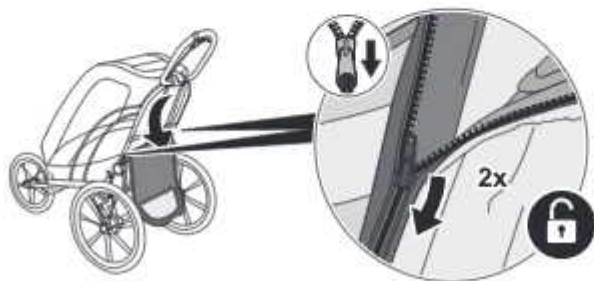

2

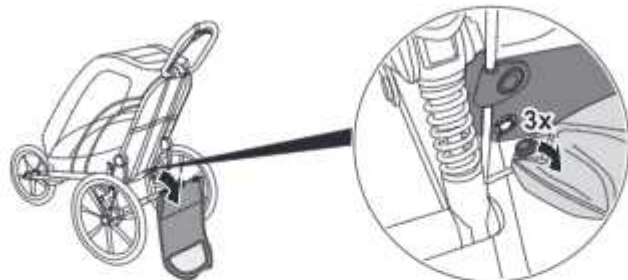

a

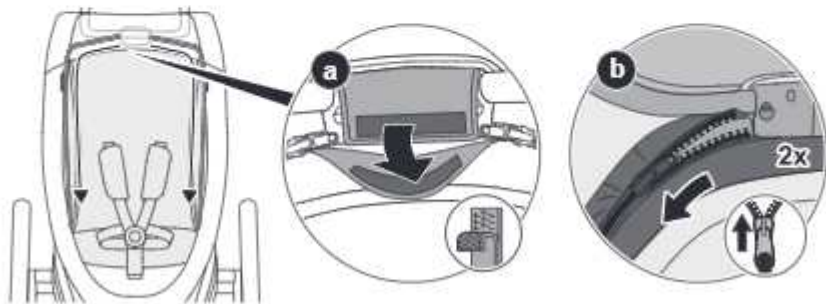

4

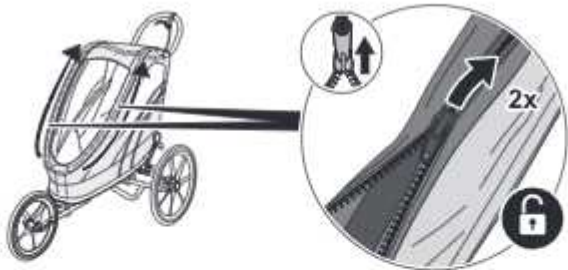

5

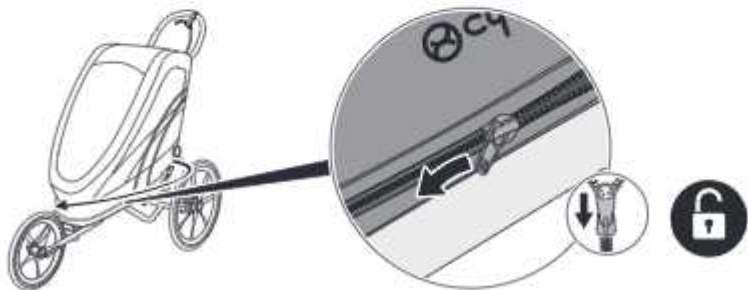

6



7



8

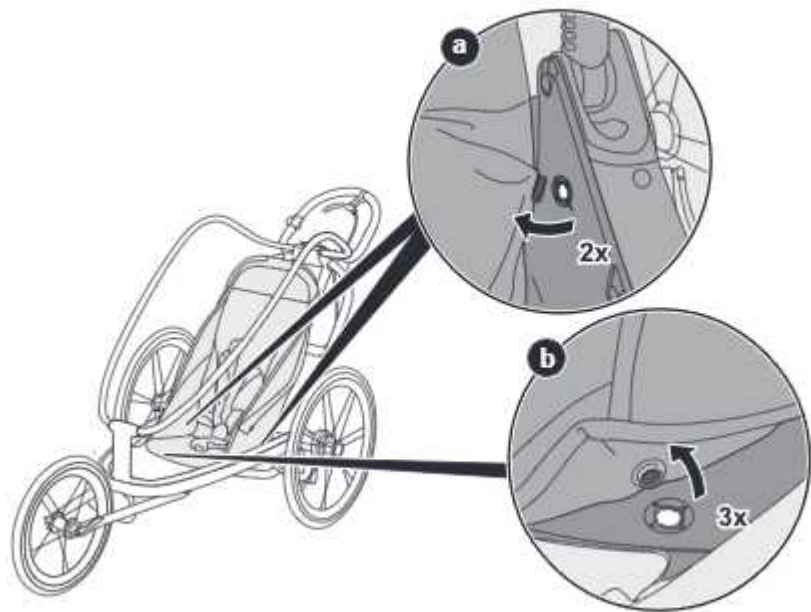

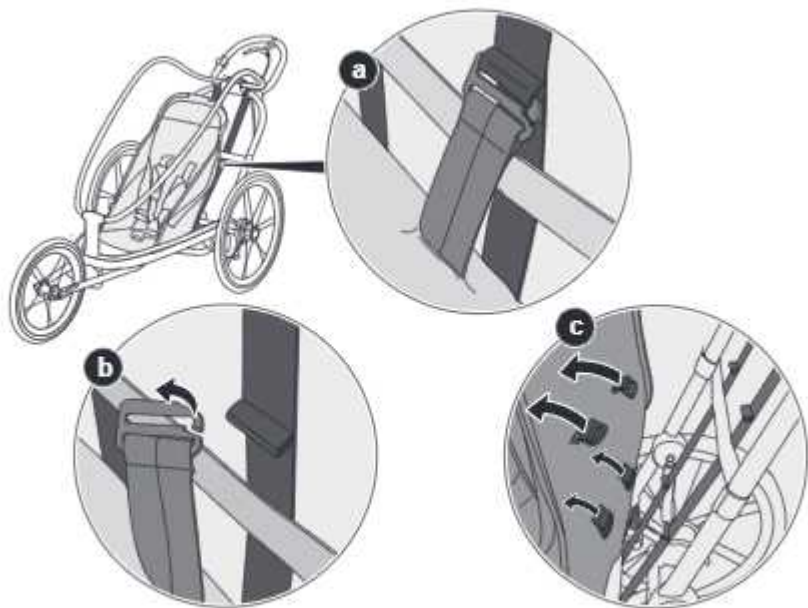

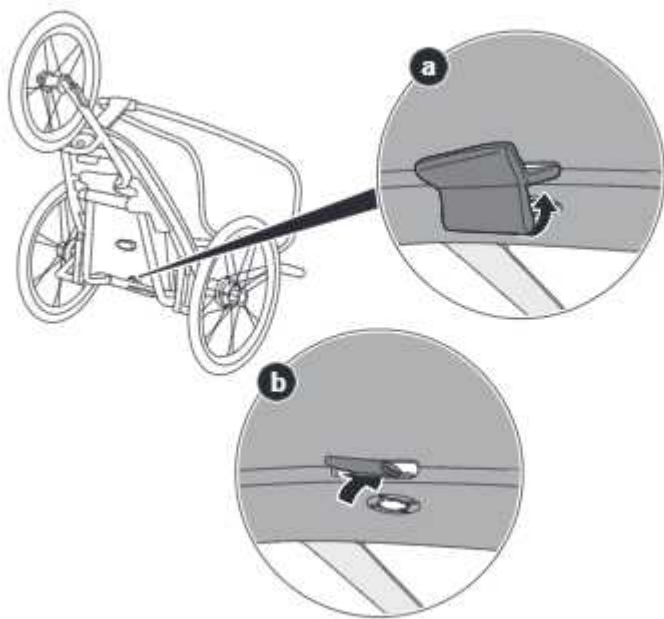

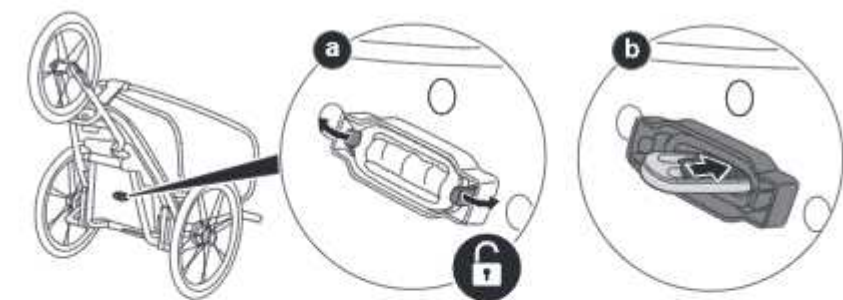

12



13

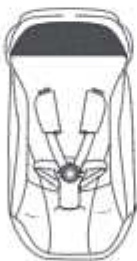
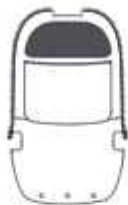
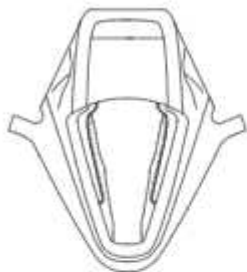



CYBEX GmbH

Riedingerstr. 18 | 95448 Bayreuth | Germany
+49 (0) 921-78 511-0 | info@cybex-online.com

AMERICAS

Columbus Trading-Partners USA Inc.
1801 Commerce Dr. | Piqua, OH 45356 | USA
Customer Service 1-844-543-2020 | support.us@columbustp.com

CANADA

Goodbaby Canada Inc.
2 Robert Speck Parkway, Suite 750 | Mississauga, ON L4Z 1H8
Customer Service / Service clients: 1-937-773-3971
support.americas@goodbabyint.com

www.cybex-online.com

