

ChelinoBaby®

Stores: ChelinoBaby – Ormonde – JHB
ChelinoBaby – Fourways – JHB
ChelinoBaby – Woodmead Square – JHB
ChelinoBaby – Greenstone – JHB
ChelinoBaby – Centurion – Pretoria
ChelinoBaby – Menlyn – Pretoria
ChelinoBaby – Kolonnade – Pretoria
ChelinoBaby – Gateway – Durban
ChelinoBaby – Cavendish Square – Cape Town
ChelinoBaby – Online – www.chelinobaby.co.za



Imported for :

ChelinoBaby Group of Companies.
No. 12 Kimberlite Road , Theta Ext 5 ,
Booyens Reserve , JHB , 2091. SA.
Tel: +2711 8352520
Info: info@chelinoplatinum.co.za

Chelino

PLATINUM

ECER129/03

The height of the children ranges from 40cm to 87cm /The weight of the children should be less than or equal to 13kg



This child safety seat has passed UN Regulation No. 129/03. Please read the full instructions before assembling and using this product.

CP001 TULIP BASE USER'S MANUAL

CHELINOBABY GROUP OF COMPANIES
NO. 12 KIMBERLITE ROAD, THETA EXT 5, BOOYSENS RESERVE, JHB 2091, SA.
Tel: +2711 8352520

www.chelinobaby.co.za



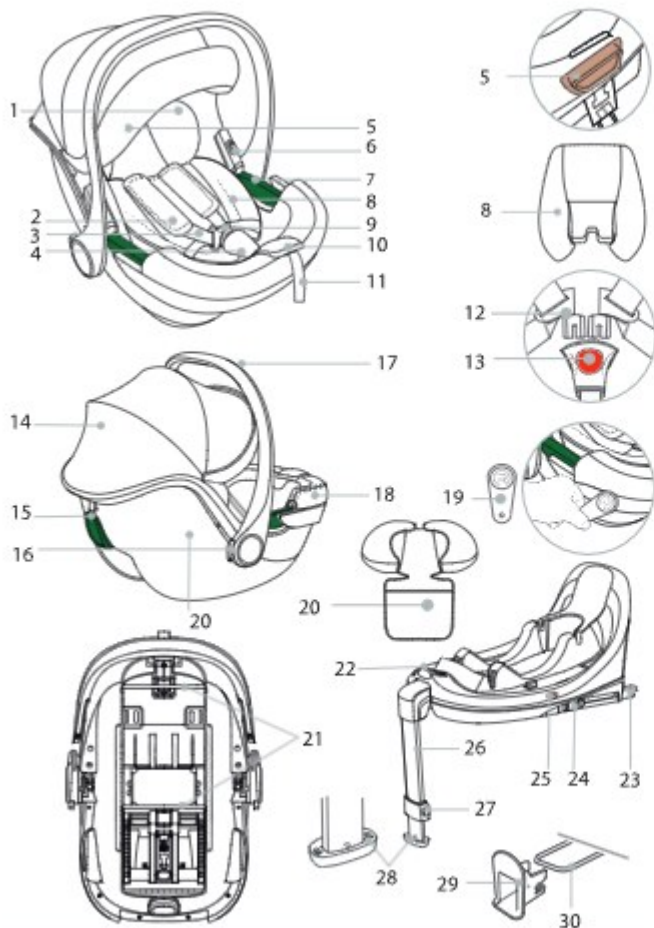

⚠ WARNING!

Read the instructions carefully before use and keep for future reference.

- 1 Headrest
- 2 Shoulder Pads
- 3 Shoulder Straps
- 4 Crotch Pad
- 5 Headrest Height Adjuster
- 6 Separate Adapter Buttons (optional for stroller)
- 7 Vehicle Lap Belt Guidance
- 8 Seat Pad Reducer
- 9 Harness Buckle
- 10 Adjustment Button
- 11 Adjustment Strap
- 12 Buckle Tongues
- 13 Red Release Button
- 14 Sunshade
- 15 Vehicle Diagonal Belt Guidance
- 16 Swivel Buttons
- 17 Handle
- 18 Seat Cover
- 19 R-elf
- 20 Instruction Storage (in the back of the headrest cover)
- 21 Metal Bars
- 22 Release Button
- 23 ISOFIX Locking Arms
- 24 ISOFIX Buttons
- 25 Base Indicators
- 26 Support Leg
- 27 Adjustment Buttons
- 28 Support Leg Indicators
- 29 ISOFIX Insertion Aids (optional)
- 30 ISOFIX Fastening Points (vehicle)

1. HANDLE

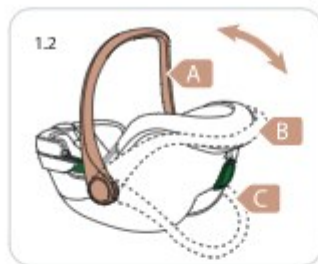

2. SUNSHADE

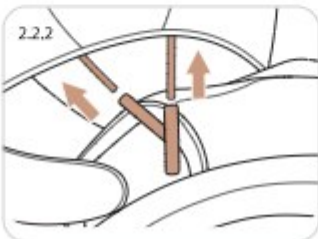
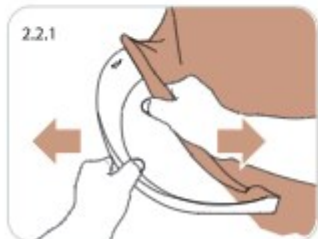
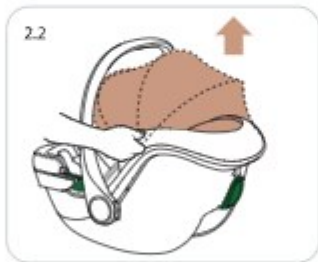
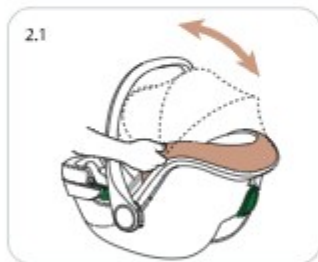

3. PUT THE CHILD IN

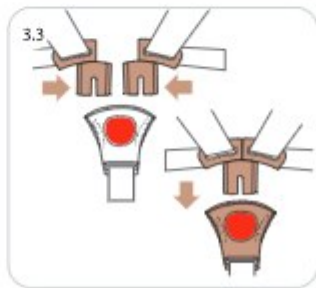
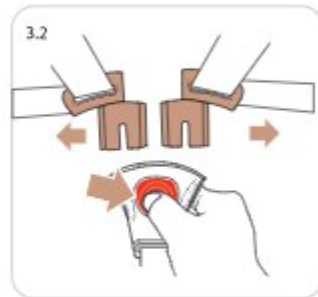
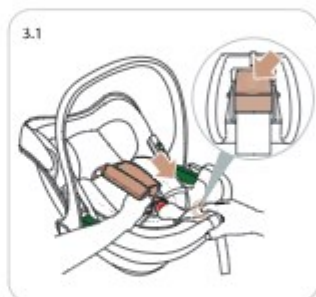

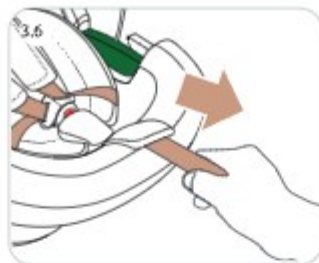
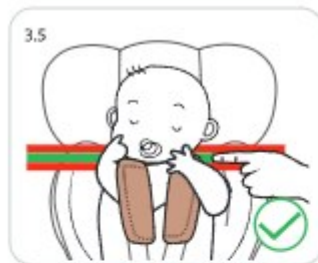

4. PREPARATORY WORK



5. INSTALLATION OF THE ISOFIX BASE

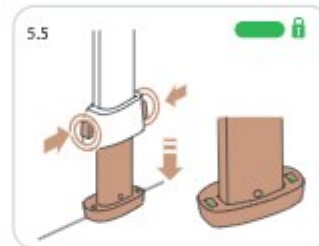
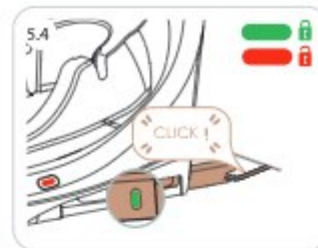
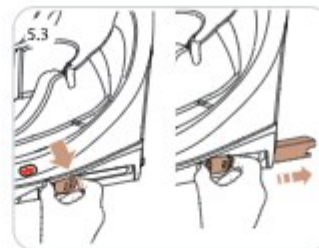
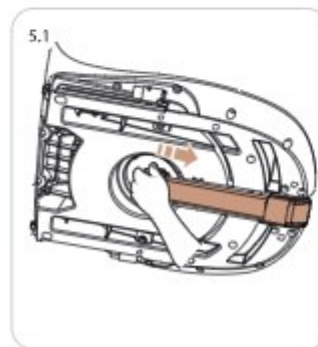

6. INSTALLATION OF THE INFANT CARRIER

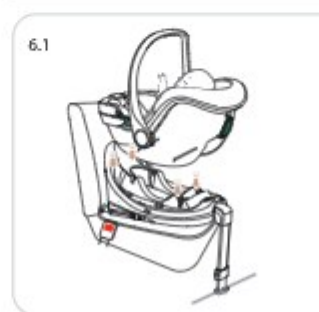

7. REMOVE FROM VEHICLE

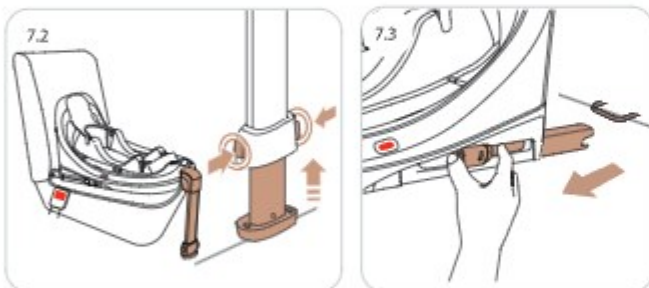
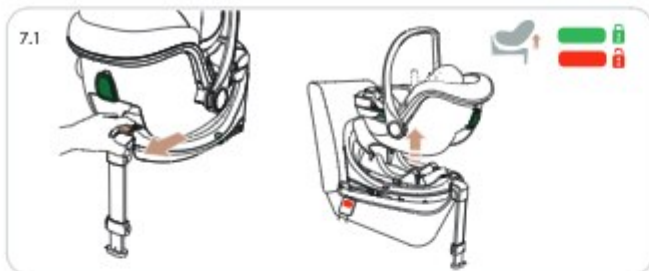

8. SEAT COVER

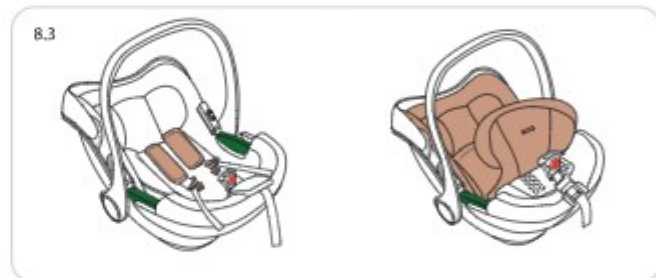
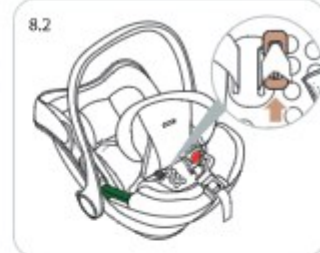
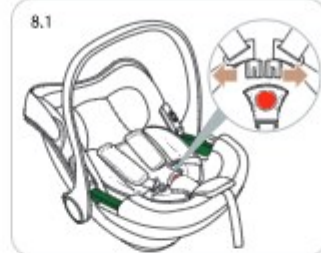



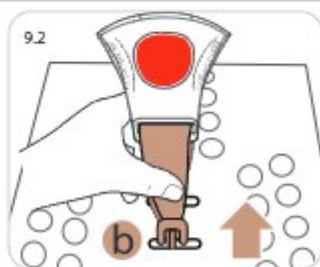
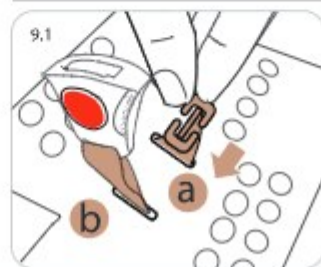

9. REMOVE HARNESS BUCKLE



APPROVAL

These instructions use the following symbols:

Symbol	Keyword	Explanation
	DANGER!	RISK of severe personal injury
	WARNING!	RISK of minor personal injury
	CAUTION!	RISK of material damage
	TIP!	Useful notes

The TULIP i-SIZE is exclusively intended to secure your child in your vehicle.

i-SIZE		
Body size	40 - 87cm ≤ 13kg	Never use the infant carrier facing forwards.
Installation method	Isofix+Support leg	

This infant carrier has been designed, tested and approved according to the requirements of the European Standard for Child Safety Equipment R129/03. This infant carrier may only be used to secure a child in the vehicle.



This ECRS is suitable for vehicles equipped with the ECE R14 requirements. And only after installing ISOFIX, then can use it.

1. HANDLE

- 1.1 Hold down both swivel buttons (16). Move handle (17) to desired position, then release swivel buttons (16). Ensure that the handle (17) with a clicking sound as shown.
- 1.2 You can adjust the handle (17) in three positions: A, B and C as shown:
A - For carrying and for transport in your car.
B - For placing your child inside.
C - For setting the infant carrier down safely outside the car.

2. SUNSHADE

The sunshade (14) protects your child's head from sunlight. It is foldable to open and close.

- 2.1 Pull the sunshade (14) to the suitable location as shown.
- 2.2 Remove sunshade (14).
 - 2.2.1 Remove cover directly from plastic front edge.
 - 2.2.2 Draw out sunshade (14) strut from black tube on both sides.
 - 2.2.3 Detach sunshade (14) from infant carrier.



TIP! If you need to clean the sunshade, please pull out the plastic support pipe in the sunshade.

Attach sunshade

Follow the steps <Remove sunshade (2.2)> in reverse order.

3. PUT THE CHILD IN

- 3.1 Loosen the shoulder straps (3) by pressing the adjustment button (10) and pull both shoulder straps (3) forwards.
- 3.2 Press red release button (13) to open the harness buckle (9). Move the harness straps to the side to place the child in the seat.

- 3.3 Bring both buckle tongues (12) together. Lock buckle tongues (12) in harness buckle (9) with a clicking sound.
- 3.4 Pull headrest height adjuster (5) from back with your thumb hold the top of the adjuster. Move the headrest (1) freely up and down to find a suitable position and then release the headrest height adjuster(5). Now the headrest is fixed in the position you want.
- 3.5 Adjust the headrest (1) to proper position. Make sure the distance between child's shoulder and the bottom of the headrest is lower than one finger.
- 3.6 Pull the adjustment strap (11) until the strap lies flat and snug on your child's body. Make sure shoulder straps slightly higher or equal to child's shoulders.

**WARNING!**

Place shoulder straps tight to the child's body.

4. PREPARATORY WORK

- 4.1 If your vehicle is not fitted with ISOFIX insertion aids (29) as standard, clamp the two ISOFIX insertion aids (29), which are included in the scope of delivery of the seat, with the opening pointing upwards, to the two ISOFIX fastening points (30) of your vehicle. If you don't have ISOFIX insertion aids (29), please ignore this step.



TIP! The ISOFIX fastening points (30) are located between the surface and the backrest of the vehicle seat.

5. INSTALLATION OF THE ISOFIX BASE

**WARNING!**

Note and follow the vehicle handbook during use, be sure to observe any restrictions relating to airbags.

- 5.1 Pull the support leg (26) away from the base bottom of the child safety seat.
- 5.2 Then you hear a clicking sound and the support leg (26) is fully extended.
- 5.3 Press the ISOFIX buttons (24) to push out the two ISOFIX locking arms (23) from the seat base.
- 5.4 Push back the base until the base is rest firmly against the vehicle seat then you hear a clicking sound. And on both sides the ISOFIX indicators turn from red to green safety color.
- 5.5 Press both adjustment buttons (27) and pull out the support leg (26) until it makes firm contact with vehicle floor and the support leg indicators (28) are green as shown, then you hear a clicking sound.
- 5.6 Make sure the base is installed well.

6. INSTALLATION OF THE INFANT CARRIER

- 6.1 Put the infant carrier on the base, insert the metal bars (21) into slot, then you hear a clicking sound. And on both sides of the base indicators (25) turn from red to green safety color. Never use the infant carrier facing forwards.

 **WARNING!** Before each car journey, in order to ensure your child's safety, make sure that---

- The seat base is fastened in the ISOFIX fastening points (30) on both sides with the ISOFIX locking arms (23) and both ISOFIX buttons (24) are fully green;
- The infant carrier is securely fastened;
- The harness of the infant carrier is fitted snugly to the child's body without being constricting and should not be twisted;
- The shoulder straps (3) are correctly adjusted and the straps are not twisted;

- The shoulder pads (2) are in the correct position on your child's body;
- The infant carrier is facing in the right direction for your child's age/size;
- The buckle tongues (12) are inserted into the harness buckle (9).

7. REMOVE FROM VEHICLE

- 7.1 Pulling the release button (22), remove the infant carrier.
- 7.2 Tuck your support leg (26) in: Press the adjustment buttons (27) to push back into support leg (26).
- 7.3 Release ISOFIX button (24) towards each other to loosen the ISOFIX fastening points (30) on both sides. Move the ISOFIX locking arms (23) back into the seat base.
- 7.4 Remove the base and put the support leg (26) into the base.

8. SEAT COVER

Only use authentic seat covers. The seat cover (18) is an integral part of the child safety seat and is key to ensure the trouble-free functionality of the system. Seat covers replacement are available from your dealer.

- 8.1 Open the harness buckle (9), refer to (3.2) as shown.
- 8.2 Open the cloth cover. Remove the metal plate from shoulder strap (3).
- 8.3 Remove shoulder pads (2) and buckle tongues (12). Remove seat cover (18).



TIP! Please keep the buckle tongues and metal plate well for further use.



TIP! Follow above steps in reverse order with R-elf (19), which can help you assemble cover more easily.



TIP! When you use infant carrier, make sure seat pad reducer underneath the shoulder straps. Make sure that the seat pad reducer is in contact with the backrest of the infant carrier.



WARNING! Use the seat pad reducer when your baby is 40-75cm. Remove the seat pad reducer when your baby is >75cm.

9. REMOVE HARNESS BUCKLE

- 9.1 Rotate the metal plate on crotch strap by 90° vertically. Slide the metal plate downward through the harness slot (a) as shown.
- 9.2 Pull crotch strap and slide the metal plate by 90° vertically upward through the harness slot (b) as shown. Remove harness buckle (9) from base.



CAUTION! Make sure the metal plate is above slot (a), crotch strap goes through slot (b).

Install harness buckle

Follow the steps (9.1)(9.2) in reverse order.

CARE AND MAINTENANCE

Child safety seat

- The cover can be removed and washed with a mild detergent in a washing.
- The baby seat pad reducer (8) can be washed in the same way as the cover. Remove all foam parts from the top and bottom sections before washing. These must not be washed.
- The shoulder pads (2) can be removed and washed in lukewarm soapy water.
- The plastic parts and the harnesses can be cleaned with soapy water. Do not use any caustic cleaning agents (such as solvents).



TIP! Use seat cover R-elf (19) to assemble cover more easily.

Harness buckle

To ensure the safety of your child, it is absolutely essential that the harness buckle continues to function correctly. Harness buckle malfunctions are usually caused by a build-up of soiling or by external objects:

- When you press the red release button (13), it takes a long time for the buckle tongues (12) to be ejected.
- The buckle tongues (12) no longer engage (i.e. when you try to push them in, they pop out again).
- The buckle tongues (12) engage without a clicking sound.
- The buckle tongues (12) are difficult to push in (If you feel a certain amount of resistance).
- The harness buckle (9) only opens if extreme force is applied.

Remedy: Soak the harness buckle in warm water containing washing-up liquid for at least an hour. Rinse the buckle thoroughly and dry it.

DISPOSAL

Please observe the waste disposal regulations in your country.

Disposal of packaging	Container for cardboard boxes
Seat cover	Residual waste, waste incineration
Plastic parts	To be placed in the corresponding container according to labelling
Metal parts	Container for metals
Belt straps	Container for polyester
Buckle and tongue	Residual waste

SAFETY NOTES

NOTICE

This is an i-Size Enhanced Child Restraint System. It is approved according to UN Regulation No. 129, for use in i-Size compatible vehicle seating positions as indicated by vehicle manufacturers in the vehicle user's manual.

If in doubt, consult either the Enhanced Child Restraint System manufacturer or the retailer.

DANGER!

Please carefully read and make sure you understand all instructions in this manual and in the vehicle handbook relate to child safety seats. Install and use the child safety seat as described in the instruction manual. Failure to do this could result in serious injury even death of your child. Keep the instructions together with the ECRS for future reference.

DANGER!

Because of potential medical issues inherent to low birth weight and premature infants, always have a trained professional doctor or hospital staff assess the suitability of the ECRS prior to leaving the hospital or using the ECRS.

MAKE SURE any straps restraining the child should be adjusted to the child's body. Make sure straps should not be twisted and any support-leg should be in contact with the vehicle floor.

HOT! The child seat should be kept away from sunlight if the seat is not provided with a textile cover, otherwise it may be too hot for the child's skin.

DO NOT leave your child unattended in this restraint even for a short time.

DO NOT leave your child unsupervised in the vehicle, for the temperature in a vehicle can rise dangerously quickly. Take breaks and take the child out of the infant carrier as often as possible, if you are on long journeys. It will be good for your child's spine.

MAKE SURE any luggage or other objects liable to cause injuries in the event of a collision shall be properly secured.

A) DO NOT use the ECRS without the cover.
B) DO NOT replace seat cover with any other than the one recommended by the manufacturer, because the cover constitutes an integral part of the restraint performance.

ONLY use rearward facing installation. (refer to instruction)

MAKE SURE the rigid items and plastic parts of a ECRS shall be so located and installed that they are not liable, during everyday use of the vehicle, to become trapped by a movable seat or in a door of the vehicle.

MAKE SURE the ECRS is changed when it has been subject to violent stresses in an accident.

DO NOT make any alteration or additions to the ECRS without the approval of the Type Approval Authority, or a danger occurs if not following closely the installation instructions provided by the ECRS manufacturer.

⚠ WARNING!

The safest place for your baby is the rear of your car. Airbags are designed to protect adults. The use of a front airbag with an infant carrier can lead to fatal injuries.

DIMENSION INFO

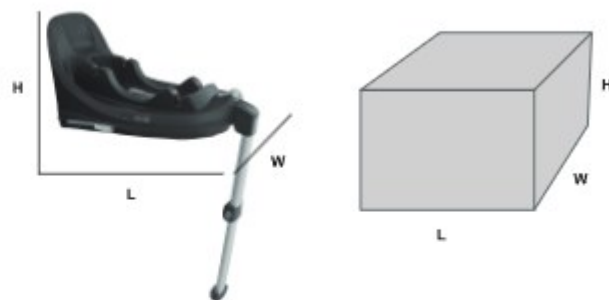

LENGTH	57 CM	CARTON LENGTH	54.5 CM
WIDTH	39 CM	CARTON WIDTH	40 CM
HEIGHT	31.5 CM	CARTON HEIGHT	32.5 CM
WEIGHT	4.2 KGS		

Due to variation on the styles and designs of our products, the photographs and illustrations shown in this manual are generic. Therefore products fabric, colour and design may vary from images shown, Chelino reserves the right to alter products specifications.