



## DELUXE WALKER INSTRUCTION MANUAL

Infant Walker and Electronic Play Tray



Read all instructions before assembly and use of the tricycle.  
Keep instructions for future use.

The child may be hurt if you do not follow these instructions.

**IMPORTANT! KEEP FOR FUTURE REFERENCE.  
WARNING! TO BE ASSEMBLED BY AN ADULT!**

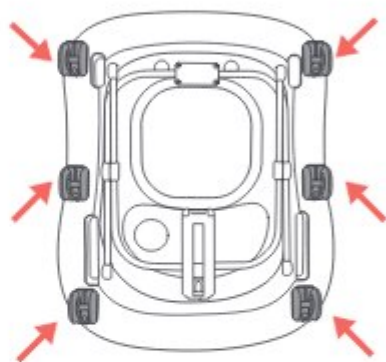
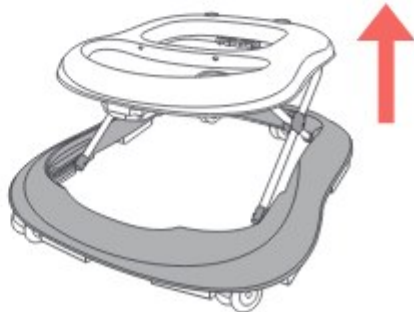
**A****B****C****D****E****1****2**

3



4



5

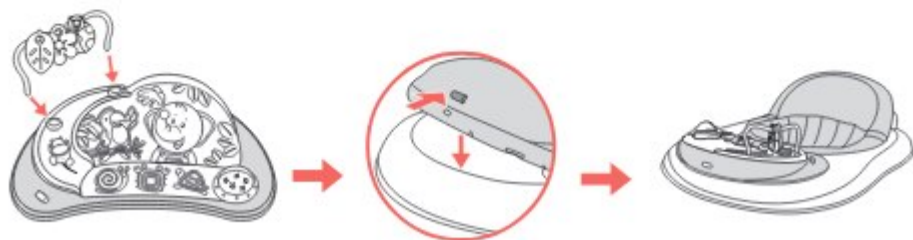

6

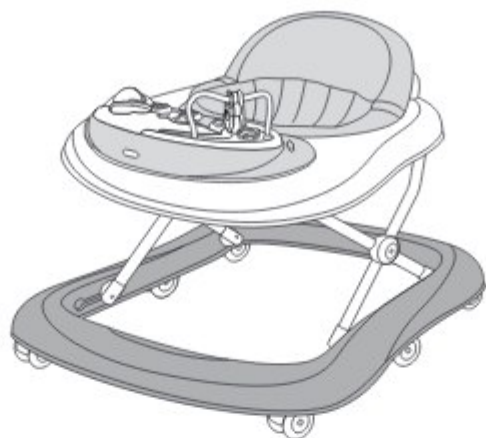

7

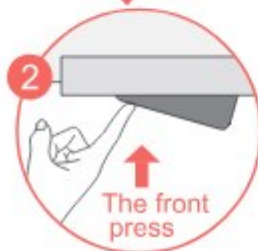
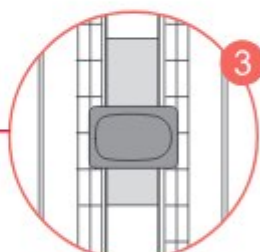

8

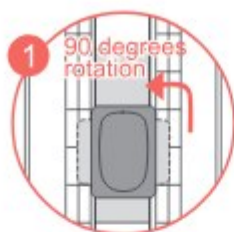

4



3

9



## **⚠ WARNING**

Read the instructions carefully before use and keep them for future reference. The child may be hurt if you do not follow these instructions.

Before using, remove and dispose of any plastic bags and other packaging (e. g fasteners, fixing ties, etc.) and keep them out of reach of children.

- Before using, check that the product and all of its components have not been damaged during transportation. Check regularly that the product is not broken or damaged. If the product is broken or damaged, keep out of reach of children.
- The product must only be assembled by an adult. For the correct assembly of the product, please refer to the following instructions.

### **⚠ WARNING**

**STAIR HAZARD:** Avoid serious injury or death. Block stairs/step

securely before using walker even when using parking brake.

- Only use the baby walker frame on flat and stable surfaces.
- Never leave child unattended.
- Always keep child in view while in walker.



### **⚠ WARNING**

The child will be able to reach further and move rapidly when in the walking frame.

Prevent access to stairs, steps and uneven surfaces, slopes or unstable floors, swimming pools or other sources of water.

- Guard all fires, heating and cooking appliances.
- Remove hot liquids, electrical cables and other potential hazards from reach.
- Prevent collisions with glass in doors, windows and furniture.
- Do not use the product if any components are broken or missing.
- This baby walking frame should be used only for short periods of time (e.g. 20min).
- This product is intended only for a child who can sit up by itself and until it is able to walk by itself or weighs more than 12kgs.
- Do not use accessories or replacement parts other than those approved by the manufacturer.

## **Parts List**

**Check that you have all the parts for this model BEFORE assembling your product. No tools required.**

A. 6 wheels

B. Handle

C. Baby walker frame

D. Padded seat

E. Electronic play tray

## Assembling Procedures

1. Turn the baby walker frame upside down. Fix the rolling wheels in the appropriate housings. Ensure that the wheels are firmly pushed all the way into the housing on the down base of the walker.
2. Open the baby walker frame in the in-use position, ensuring that all wheels touch the floor. Slowly raise the tray by pulling it in an upward direction, until a click indicates that the frame has been locked correctly in one of the three positions.
3. Insert the plastic rings of the padded seat in the slots located along the upper edge of the walker frame. Pass the rings through the slots and tug them until they clear the passage, then release them, ensuring that they are correctly locked in the position and cannot recede into the slot.
4. Fit the handle on the rear walker frame; simply place it on the housings, located at the rear of the backrest, and push it firmly in a downward direction, ensuring that it has been fitted in the correct position. Please do not lift up baby walker with handle. It is dangerous do in this way.
5. Insert all small toy parts into corresponding holes. Put the electronic play tray into its housing in front of the walker's seat. Listen for two click to confirm the play tray is safely locked in place.
6. Completely assembled.

## How to Adjust the Height of Baby Walker Frame

**WARNING:**When opening, closing or adjusting the walker, ensure that your child is at a safe distance. Before placing the child in the walker ensure that the secondary lock button is correctly locked again.

7. To adjust the seat's height, remove the child from the baby walking frame, pull the safe button located under the small tray table and rotate it to 90 degrees. keep the safe button pressed, then raise or lower the small table until the desired position is reached, then pull the safe button and rotate it to 90 degrees again to lock the small table.(If it is a automatic secondary lock, please make sure the lock has rotated to 90 degrees.)

## How to Fold the Walker

8. Firstly, pull the button under top tray, make sure the button finally parallel to the adjusted-device(see 1st picture). Meanwhile, press up the front postion(see 2nd picture), and press down the top base till the end. The frame folds up completely.

## Fitting and / or Replacing Batteries

### WARNING

The toy of the walker frame requires 2X"AA" 1.5Volt alkaline type batteries(not included).

- Batteries must only be fitted by an adult.
- To fit and/ or replace batteries: loosen the screw on the battery compartment cover with a suitable screwdriver, press the tab and remove the battery compartment cover. Then remove the spent batteries and fit new ones, ensuring that they have been fitted in the correct polarity, as shown inside the battery compartment. Replace the battery cover and tighten the screw.
- Always keep batteries and tools out of reach of children.
- Always remove the batteries if the toy will not be used for a long period.
- Only use alkaline batteries of the same type of equivalent to the type recommended for the correct function of this product.
- Never mix new and old batteries, or different types of batteries.
- Do not burn or dispose of spent batteries into the environment. Dispose of spent batteries at an appropriate differentiated collection point.
- The use of rechargeable batteries is not recommended and cannot be used.
- Non-rechargeable batteries are not to be recharged.
- Rechargeable batteries are to be removed from the toy before being charged.
- Rechargeable batteries are only to be charged under adult supervision.
- Batteries are to be inserted with correct polarity.
- Exhausted batteries are to be removed from the toy.
- Do not short-circuit the battery terminals.

## Product Care and Maintenance

- Check regularly the walker frame for signs of damage or wear.
- Clean the plastic parts, including the stoppers, with a damp cloth.
- Clean the seat with brush or family soap and neutral scour
- Dry the metal parts to prevent the formation of rust.
- Prolonged exposure to direct sunlight may cause the fabric to fade.



## Dimension Info

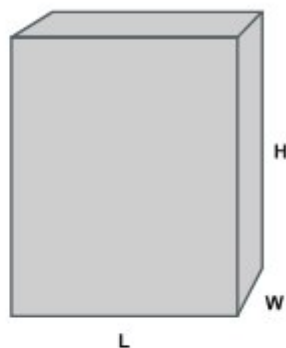

---

BABY WALKER LENGTH	78 CM	CARTON LENGTH	64 CM
BABY WALKER WIDTH	64 CM	CARTON WIDTH	11 CM
BABY WALKER HEIGHT	56.5 CM	CARTON HEIGHT	79 CM

---

BABY WALKER WEIGHT      4.22 KGS

Due to variation on the styles and designs of our products, the photographs and illustrations shown in this manual are generic. Therefore products fabric, colour and design may vary from images shown, Chelino reserves the right to alter products specifications .

# ChelinoBaby®

Stores: ChelinoBaby – Ormonde – JHB  
ChelinoBaby – Fourways – JHB  
ChelinoBaby – Woodmead Square – JHB  
ChelinoBaby – Greenstone – JHB  
ChelinoBaby – Centurion – Pretoria  
ChelinoBaby – Menlyn – Pretoria  
ChelinoBaby – Kolonnade – Pretoria  
ChelinoBaby – Gateway – Durban  
ChelinoBaby – Cavendish Square – Cape Town  
ChelinoBaby – Nelspruit – Mpumalanga  
ChelinoBaby – Online – [www.chelinobaby.co.za](http://www.chelinobaby.co.za)



Imported for :

ChelinoBaby Group of Companies.

No. 12 Kimberlite Road , Theta Ext 5 ,  
Booyens Reserve , JHB , 2091. SA.

Tel: +2711 8352520

Info: [info@chelino.co.za](mailto:info@chelino.co.za)